



MOTOROLA

User's Guide

TIMEPORT™

PERSONAL INTERACTIVE COMMUNICATOR



Model P935
ReFLEX™ Technology

Motorola, Inc. makes no representations or warranties with respect to the contents or use of this manual and specifically disclaims any warranties, express or implied, of merchantability or fitness for any specific purpose. Further, Motorola, Inc. reserves the right to revise this publication and to make any modifications to its content, at any time, without obligation to notify any party, person, or entity of such revisions or changes.

Personal Communications Sector
1500 Gateway Blvd.
Boynton Beach, FL 33426-8292

MOTOROLA, the Stylized M logo and all other trademarks indicated as such herein are trademarks of Motorola, Inc. © Reg. U.S. Pat. & Tm. Off.

Starfish, TrueSync, and the Starfish logo are trademarks of Starfish Software, Inc. U.S. Patent Nos. D388,776 (TrueSync Desktop only), 5,519,606 and 5,778,346. Other patents pending.

All other product or service names are the property of their respective owners.

© 2000 Motorola, Inc. All rights reserved. Printed in the U.S.A.

SOFTWARE LICENSE AGREEMENT

This is a legal agreement between you, the end-user, and Motorola, Inc., ("Motorola"). The Wisdom™ Operating System ("Wisdom OS"), the Applications pre-installed in your Timeport® P935 device, and the PC Partner, (collectively "Software"), are licensed by Motorola to you, and any subsequent transferee of the Software for use only under the terms set forth here. Please read this Software License Agreement ("Agreement"). By installing, copying or using the Software, you agree to be bound by all the terms of this Agreement. If you do not agree with the terms of this Agreement, promptly return the Timeport P935 device and the unused Software to the place from which you obtained them for a full refund.

GRANT OF LICENSE: Motorola grants you a limited, non-exclusive, revocable license to use the executable-code version of the Wisdom OS and the Applications for your personal use on a single Motorola Timeport P935 device; and Motorola grants you a limited, non-exclusive, revocable license to use the executable code version of the PC Partner for your personal use on a single personal computer. All rights not expressly granted to you are reserved by Motorola.

COPYRIGHT: The Software is owned by Motorola and is protected by United States copyright laws and international treaty provisions. You acknowledge that no title to any intellectual property in the Software is transferred to you.

LIMITATIONS: Except as otherwise explicitly permitted in this Agreement, you may not: a.) modify, translate or adapt the Software or create derivative works of the Software or any part thereof; b.) decompile, disassemble, reverse engineer, or otherwise attempt to derive the source code of the Software; c.) copy (except to install the Wisdom OS and the Applications into a single Motorola Timeport P935 device; and except to make one archival back-up copy of the PC Partner), re-distribute, encumber, sell, rent, loan, lease, sub-license, assign or otherwise transfer your rights to the Software; or d.) remove or alter any trademark, logo, copyright, or other proprietary notices in the Software. You may transfer all your rights to the Software under this Agreement to another person by transferring, on a permanent basis, to such other person the Motorola Timeport P935 device on which the Wisdom OS and Applications are installed, or by transferring, on a permanent basis, to such other person the personal computer on which the PC Partner is installed; provided that you retain no copy of the Software and that the transferee agrees to all the terms of this Agreement.

HIGH RISK ACTIVITIES: The Software is not fault-tolerant and is not designed, manufactured or intended for use in hazardous environments requiring fail-safe performance, such as in the operation of nuclear facilities, aircraft navigation or communication systems, air traffic control, implantable human medical devices, external human life-support machines, explosives control devices, submarines, weapons systems, or in controlling the operation of moving motor vehicles, in which the failure of the Software could lead directly to death, personal injury, or severe physical or environmental damage ("High Risk Activities"). You agree not to use the Software in High Risk Activities.

U. S. GOVERNMENT RESTRICTED RIGHTS: The U. S. Government acknowledges Motorola's representation that the Software and its documentation were developed at private expense and no part of them is in the public domain and that the Software is Restricted Computer Software as that term is defined in Clause 52.227-19(FAR) and is Commercial Computer Software as that term is defined in Subpart 227.471 DFARS).

RESTRICTED RIGHTS LEGEND: Where applicable, use, duplication or disclosure by the U. S. Government is subject to restrictions as set forth in subparagraph(c) (1) (ii) of the Rights of Technical Data and Computer Software clause at DFARS 252.227-7013. Contractor/manufacturer is Motorola Inc., 1303 E. Algonquin Rd., Schaumburg, IL 60196.

EXPORT LAW ASSURANCES: THIS SOFTWARE IS NOT FOR EXPORT.

Except for export to Canada for use in Canada by Canadian citizens, the Software and any underlying encryption technology may not be exported outside of the United States or to any foreign entity or "foreign person" as defined by the U. S. Government regulations, including without limitation, to any person who is not a citizen, national or lawful permanent resident of the United State. You agree to comply fully with the export regulations of the United States of America. You agree that you will not export the Software without an export license issued by the U. S. Department of Commerce. You agree to comply with all regulatory sanctions or restrictions involving a party or an entity identified as Denied Parties or Specially Designated Nationals by the U.S. Department of Commerce and/or the U.S. Department of Treasury.

GENERAL: This Agreement will be governed by the laws of the State of Illinois, U.S.A., except for that body of law dealing with conflicts of law.

LIMITED WARRANTY: Motorola warrants that each copy of the Software will be free from physical defects in the media that tangibly embodies the copy for a period of ninety (90) days from the date the product accompanying the Software was purchased by you. Motorola, at its option, will at no charge repair or replace the media of the Software that contains defects in materials or workmanship in the media. No updates are provided. Motorola makes no warranty or representation that the Software will meet your requirements or will work in combination with any hardware or applications software products provided by third parties, that the operation of the Software will be uninterrupted or error free, or that all defects in Software will be corrected. The entire risk as to the quality and performance of the Software is with you. EXCEPT FOR THE ABOVE NINETY (90) DAY WARRANTY, THE SOFTWARE IS PROVIDED WITHOUT FURTHER WARRANTY OF ANY KIND, EITHER EXPRESS OR IMPLIED, INCLUDING, BUT NOT LIMITED TO, THE WARRANTIES OF TITLE, NON-INFRINGEMENT, MERCHANTABILITY, AND FITNESS FOR A PARTICULAR PURPOSE. NO ORAL OR WRITTEN INFORMATION OR ADVICE GIVEN BY MOTOROLA, ITS EMPLOYEES, DISTRIBUTORS, DEALERS OR AGENTS SHALL INCREASE THE SCOPE OF THE ABOVE WARRANTIES OR CREATE ANY NEW WARRANTIES. SOME JURISDICTIONS DO NOT ALLOW THE EXCLUSION OF IMPLIED WARRANTIES, SO THE ABOVE EXCLUSION MAY NOT APPLY TO YOU. IN THAT EVENT, ANY IMPLIED WARRANTIES ARE LIMITED IN DURATION TO NINETY (90) DAYS FROM THE DATE OF DELIVERY OF THE SOFTWARE. THIS WARRANTY GIVES YOU SPECIFIC LEGAL RIGHTS. YOU MAY HAVE OTHER RIGHTS, WHICH VARY FROM STATE TO STATE.

LIMITATION OF LIABILITY: REGARDLESS OF WHETHER ANY REMEDY SET FORTH IN THE WARRANTY FAILS OF ITS ESSENTIAL PURPOSE, IN NO EVENT WILL MOTOROLA BE LIABLE TO YOU FOR ANY SPECIAL, CONSEQUENTIAL, INDIRECT, INCIDENTAL OR SIMILAR DAMAGES, INCLUDING LOST PROFITS OR LOST DATA ARISING OUT OF THE USE OR INABILITY TO USE THE SOFTWARE OR ANY DATA SUPPLIED THEREWITH EVEN IF MOTOROLA OR ANYONE ELSE HAS BEEN ADVISED OF THE POSSIBILITY OF SUCH DAMAGES, OR FOR ANY CLAIM BY ANY OTHER PARTY. SOME JURISDICTIONS DO NOT ALLOW THE LIMITATION OR EXCLUSION OF LIABILITY FOR INCIDENTAL OR CONSEQUENTIAL DAMAGES SO THE ABOVE LIMITATION OR EXCLUSION MAY NOT APPLY TO YOU. IN NO CASE SHALL THE LIABILITY OF MOTOROLA EXCEED THE PRICE PAID FOR THE SOFTWARE.

TERM: This Agreement is effective until terminated. This Agreement will terminate, and the license granted to you by this Agreement will be revoked, immediately, without any notice from Motorola, if you fail to comply with any provision of this Agreement. Upon termination, you must destroy the Software.

General Safety Instructions

Follow these guidelines to help ensure the safe use of your Timeport P935 device and accessories.

Device Transmitter Safety

The FAA has regulations concerning the use of electronic devices aboard aircraft. When boarding an aircraft, set the radio transmit status on your Timeport P935 device to Off to avoid potential interference with aircraft radio communication or navigation equipment.

In hospital or blasting zones, set the transmit status to 1-Way. This prevents potential transmission interference with sensitive medical equipment or explosive devices.

Battery Safety

- Do not dispose of the rechargeable NiMH battery in fire. Batteries can explode when exposed to fire.
- To prevent injury or burns, do not allow metal objects to contact or short circuit the battery terminals.
- Recharge the Motorola 3.6 V NiMH battery (0186386G01) only with the recommended Motorola battery charger (0186388G02). Charging this battery by any other method or with a product not approved by Motorola may cause damage to the battery.
- Do not charge batteries other than Motorola's 3.6 V NiMH battery (0186386G01) in the Motorola battery charger (0186388G02). Charging other batteries can cause those batteries to burst or explode, resulting in personal injury or property damage.

Battery Charger Safety

- Do not expose the charger to rain or snow.
- Use of an attachment not recommended or sold by Motorola may result in a risk of fire, electric shock, or injury to persons.
- Make sure the cord is located where it will not be stepped on, tripped over, pinched, or subjected to damage or stress.

- If you need to use an extension cord, make sure:
 - The pins on the plug of the extension cord are the same number, size, and shape as those on the plug of the charger.
 - The extension cord is properly wired and in good electrical condition.
 - The cord size is 18AWG for lengths up to 100 feet and 16AWG for lengths up to 150 feet.
- Do not operate the charger with a damaged cord, transformer block, or prongs; replace them immediately.
- Do not operate the charger if it has been damaged in any way; take it to a qualified service technician.
- Do not disassemble the charger; if service or repair is required, call Motorola at 1-800-548-9954. Incorrect reassembly can result in a risk of electrical shock or fire.
- Maximum ambient temperature around the power supply must not exceed 40 C (140 F).
- Keep battery contacts clean. Do not allow dirt or sticky substances to accumulate on the contacts. If you need to clean the contacts, unplug the charger to reduce the risk of electrical shock. Use a slightly dampened cloth to clean the contacts. Let the contacts dry before plugging the charger into an AC outlet.
- **Do not immerse in water.**

Agency Approvals

The Timeport P935 messaging device has been approved for use by the Federal Communications Commission (FCC) and Underwriter's Laboratories, Inc. (UL). The charger base has been FCC approved and the transformer has been UL approved.

Patent Information

This product is manufactured under one or more Motorola U.S. Patents. A partial listing of these patents is provided inside the battery compartment. Other patents covering this product are pending.

Cleaning Your Timeport P935 Device

To clean smudges and grime from the exterior of your device, use a soft, non-abrasive cloth moistened in a mild soap and water solution. Use a soft, damp cloth to clean smudges and grime from your Timeport P935 messaging device. **Do not immerse in water. Do not use alcohol or other cleaning solutions.**

Care and Maintenance

The Motorola Timeport P935 messaging devices are durable, reliable, and can provide years of dependable service; however they are precision electronic products. Water and moisture, excessive heat, and extreme shock may damage the device. Do not expose your device to these conditions. If repair is required, the Motorola Service Organization, staffed with specially trained technicians, offers repair and maintenance facilities throughout the world.

To protect the operating system, applications, and data on your Timeport P935 messaging device, ensure that the PC from which you download files is protected by up-to-date virus protection software. Remember to archive your data as needed.

You can protect your device purchase with an optional extended limited warranty covering parts and labor. For more information about limited warranties, please contact either your paging service provider, retailer, or Motorola, Inc. at 1-800-548-9954. For repairs, call Motorola, Inc., at 1-800-548-9954 in the U.S. or 1-800-461-4575 in Canada. In the U.S., to contact Motorola, Inc., on your TTY, call 1-800-793-7834.

Questions?

For questions about the use of your Timeport P935 device, call 1-800-548-9954 or 1-800-793-7834 (TTY) in the U.S. For questions pertaining to your paging service, contact your paging service provider. For information about other Motorola products, please visit our website at www.motorola.com

Welcome

Congratulations! Your new Motorola Timeport™ P935 personal interactive communicator is about to change the way you communicate. The Timeport P935 device can offer you quick access to essential information. You can benefit from the extended reach of the Internet and email, interface with your desktop computer applications and enjoy the convenience and portability of two-way messaging. This feature-rich device can provide real wireless business and PIM solutions — all in a single, well-designed device that fits right in the palm your hand.

Note *Internet and e-mail connectivity are network and subscription dependent features and may not be available in all areas.*

The Timeport P935 device includes user-upgradeable system software and applications that place you in control of your personal communications. Using the lighted QWERTY keyboard and high-resolution graphics display, you can now send messages, control incoming messages, and customize the device with applications that you select. You can also beam information to other devices or printers that support infrared (IR) beaming.

Offering power in an ultra-portable package, the Timeport P935 device features 4.5 MB of total memory. Driven by Motorola's Wisdom™ Operating System 1.0, the device is capable of rapid address book processing, sequential name searching, and message transfer and data synchronization with a compatible desktop or notebook computer.

Note *The P935 is designed to synchronize with basic features of the initial release of many popular Personal Information Management (PIM) software and hardware products.*

Messaging Service Instructions

To begin messaging service, contact your wireless messaging service provider for activation instructions. Your PIN number and the phone number of the paging service can be found in the literature provided by the paging service.

Using this Manual

This manual uses several conventions to differentiate between keyboard keys on your Timeport P935 device and buttons you select from a Timeport P935 application screen.

Specific conventions are also used to highlight additional helpful information in the form of tips, notes, and cautions. Before you begin using this manual, make certain you are familiar with these conventions:

Keys you press	When you are instructed to press a single key on the Timeport P935 device keyboard, the key name appears in small caps. For example: Press NAVDISC down to see more information.
----------------	--

Buttons you select	When you are instructed to select a button, press the TAB key to highlight the button and then press the ENTER key to select it.
--------------------	--

TIP

Identifies actions you can perform to increase your ease of use and efficiency.

Note

Provides further information about the procedural step or feature.

Caution

Identifies actions that can cause loss of data or damage to the product.

Getting Assistance

The Timeport P935 personal interactive communicator comes with a variety of support tools. To become familiar with the product, we recommend that you go through the Quick Start Guide, this Desktop Install Guide and the interactive demo and user manual included on the CD before attempting installation or operation.

In the event that you need further assistance, Motorola offers a variety of technical support options. Most problems can be resolved using FAQs listed at <http://motorola.com/P935>. TrueSync specific FAQs can be obtained at <http://techsupp.starfish.com/motorola>.

If you require further assistance, contact Motorola customer support at 1-800-548-9954 (USA) or 1-800-461-4575 (Canada) , Monday - Friday, from 8 AM to 8 PM EST. Motorola provides free customer support for non-technical matters, which include questions regarding product availability, features, specifications, and parts replacement. Technical support for software is available complimentary for 90 days from the date of your first technical support call. After 90 days, there will be a charge for such assistance.

Contents

Chapter 1 Using Your Timeport P935

The Flip™ Keypad Cover	19
The Keyboard	20
Navigation Keys	20
Special Function Keys	20
The Home Screen	21
The Desktop	21
The Menu Wheel	21
The Status Line	22
Using Timeport P935 Application Screens	23
The Battery and Charger	24
Determining the Battery Power	25
Recharging the Battery	25
Replacing the Battery	26
The Docking Station	27
Connecting the Docking Station to Your Computer	27
The Holster	28
Turning your Timeport P935 Device On and Off	28
Configuring Your Timeport P935 Device	28
Setting Time and Date	29
Creating Your Signature	29
Entering Your Owner Information	29
Setting the Alert Volume Level	29
Setting Transmit Status	30
Setting Preferences	30
Beaming Items	31
Receiving Incoming Items	32

Chapter 2 Using Common Features

Using Categories	33
Using Cut, Copy, and Paste	35
Inserting Text	36
Sending Information	38
Marking Private Entries	39
Using Trashcan	40
Using Find	43
Using Express	45
Using Help	47

Chapter 3 Messages

Receiving New Text Messages	49
About Write	50
Creating and Sending New Messages	51
Entering a One-Time Address	52
Scheduling a Delayed Send	53
Creating a List of Favorite Recipients	53
Attaching Message Replies	55
About Read	56
Reading Messages	56
Replying to Messages	57
Forwarding Messages	58
Moving Messages to Folders	58
Deleting Messages	59
About Folders	59
About the Inbox	60
About the Drafts Folder	61
About the Outbox	61
About the Sent Messages Folder	62
Working with Folders	63
Creating New Folders	63
About Message Rules	65
Creating Message Rules	65
Editing Message Rules	66
Deleting Message Rules	67
Setting Message Preferences	67
Using Common Timeport P935 Features with Read and Write	68

Chapter 4 Contacts

Entering Contacts69
Editing a Contact Entry71
Deleting Contact Entries72
Looking up Contact Entries.73
Setting Contact Preferences74
Creating a Mailing List75
Using Common Timeport P935 Features with Contacts77

Chapter 5 Calendar

Viewing Events79
Day View80
Week View80
Month View81
Adding an Event81
Receiving Event Reminders84
Editing an Event85
Deleting Events.85
Setting Calendar Preferences87
Using Common Timeport P935 Features with Calendar88

Chapter 6 Tasks

Prioritizing Tasks.89
Creating a Task.90
Editing a Task.91
Viewing a Task92
Marking a Task as Completed.92
Deleting Tasks93
Sorting Tasks94
Using Common Timeport P935 Features with Tasks95

Chapter 7 Memos

Viewing a Memo97
Composing and Editing Memos.98
Deleting Memos99
Using Common Timeport P935 Features with Memos101

Chapter 8 Alarm Clock

Viewing Your Alarms	103
Setting Alarms	104
Turning Alarms On and Off	105
Setting Alarm Clock Options	105
About Alarm Sounding Mode	106

Chapter 9 Calculator

Calculator Buttons	107
Keyboard Shortcuts	108
Using Calculator	109
About Formulas	109
Setting Calculator Options	111

Chapter 10 Jukebox

About Jukebox Alerts	113
Playing Jukebox Alerts	114
Downloading Additional Jukebox Alerts	114
Turning Jukebox Alerts On and Off	115
Composing or Editing a Jukebox Alert	115
Deleting Jukebox Alerts	116
Using Alert Script Language	117
The Basics	117
Formatting Your Alert Script Language Text	117
Using Multiple Octaves	118
Assigning Note Values	118
Using Rests	120
Maximum Alert Lengths	121
Adding Sharps, Flats, Naturals, and Accidentals	121
Tempo	123
Staccato and Legato	123
Volume	124
Special Effects	125
Sample Alert Script Language Alerts	126
Alert Script Language Quick Reference	129

Chapter 11 Control Panel

About Control Panel	132
Managing System Information	133
Viewing About Timeport Information.	133
Working with Memory Manager	133
Deleting Add-On Applications	135
Running the Clean Up Utility.	136
Enabling and Disabling Alerts	137
Using Alert Settings	137
Using LED Alerts	138
Using Quiet Time	138
Managing Desktop, Fax, Print, and Beam Settings	139
Maintaining Synchronization Settings.	139
Setting Up Internet Fax Service	141
Specifying a Printer	141
Specifying Beaming Settings.	142
Customizing the User Interface.	143
Setting the Contrast Level	143
Using Key Clicks	144
Using the Home Screen Manager	145
Setting the Date and Time	147
Setting the Transmission Mode.	148
Creating Text Entry Shortcuts.	150
Using Quick Text.	150
Using AutoType.	151
Using Signature.	153
Entering Owner Information.	154
Protecting Your Information	155

Motorola Limited Warranty For Pagers

The Timeport P935 device's lightweight, wearable design allows you to open the Flip keypad cover and read your messages while the device is still in the belt holster. Audio and vibrate alerts notify you of incoming and waiting messages. The keyboard provides text entry capabilities that allow you to send full text messages. All this is combined with the ability to add applications, upgrade current applications, and, with the infrared interface in the Motorola Deluxe charger base, synchronize your PIM information with your desktop computer.

TIP *The Timeport P935 Personal Interactive Communicator displays a blank screen to conserve energy during periods of inactivity. Press any key to awaken the device.*

The Flip™ Keypad Cover

The front keypad cover on the Timeport P935 device houses and protects its LCD screen. Opening the cover awakens the display screen, while closing the cover puts the screen into sleep mode. When in sleep mode, your Timeport P935 device continues to work for you. It receives and stores incoming messages for access at your convenience. You can set loud or soft audible or vibrating alerts to notify you when messages are received. If you do not want to be alerted when new messages arrive, you can set the alert mode to silent.

The Keyboard

The Timeport P935 device comes with a QWERTY keyboard with easy-to-use navigation keys and special function keys.

Navigation Keys

To navigate through the Timeport P935 applications, become familiar with the following keys and their functions.

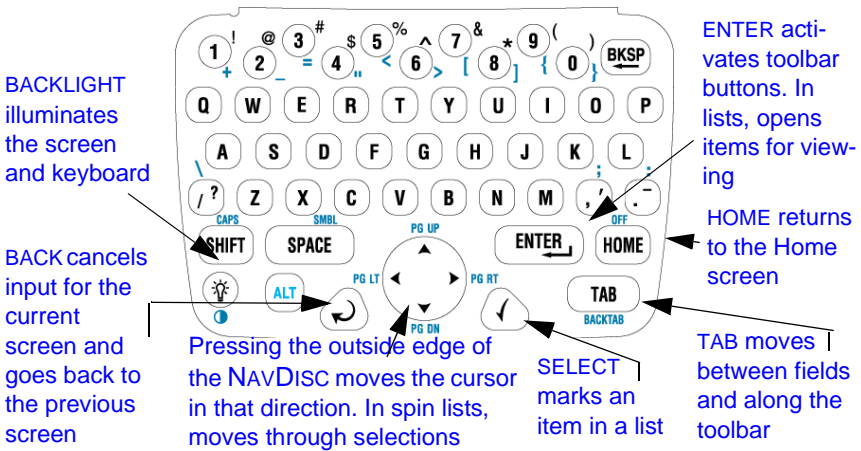

Special Function Keys

Special control keys and key combinations provide access to additional functions (known as alt-mode and shift-mode functions).

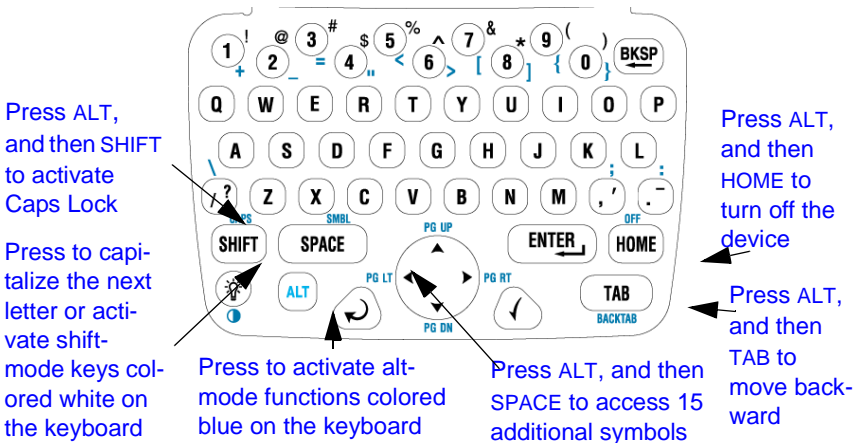

The Home Screen

The Home screen provides quick access to both pre-loaded applications and those you add yourself. The Timeport P935 device enables you to choose between two Home screen formats: the Menu Wheel or Desktop. (See Chapter 11, "Control Panel," for instructions on setting preferences for Home screen formats.)

The Desktop

To launch applications from the Desktop, press the NAVDISC in any direction to move between applications. Press the ENTER key to launch the highlighted application.

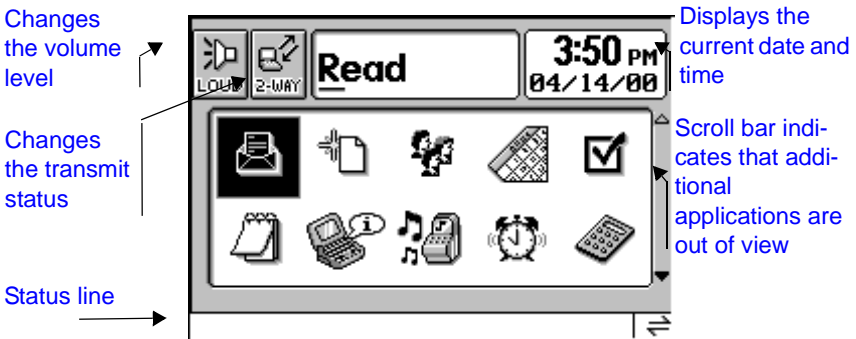

The Menu Wheel

To launch applications from the Menu Wheel, press the NAVDISC down to spin the wheel and display the next three applications. Continue pressing NAVDISC down to display all applications in succession. Press ENTER to launch the highlighted application.

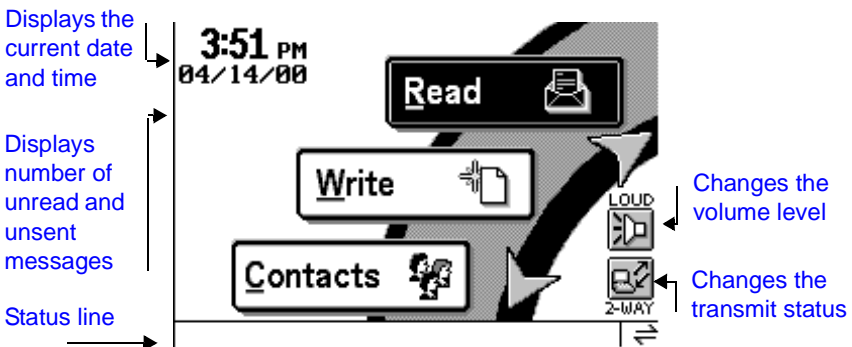

TIP Type the first letter of the application's name. The Home screen displays the first application beginning with the letter you typed. If more than one application starts with the same letter, the shortcut takes you to the first occurrence of the letter. Press the letter again to move to the next occurrence of the letter.

Type the hot key assigned to the application. The hot key appears next to the application icon. You can assign hot keys for up to nine applications.

The Status Line

The Home screen contains a status line that includes graphic indicators for the following conditions.

New Message

 New message is waiting.

Sending Status

»» Message is waiting to be sent.

✓ Message sent.

✕ Message could not be sent.

Memory

 Low memory.

Charging

 Communicator is in charger base and is charging.

Alarm Set

 An alarm is set in the Alarm Clock application.

Coverage Status

- ⇔ Device is in two-way range and can send and receive messages.
- ☑ Device is in one-way range and can only receive messages.
- ✖ Device is out of range and cannot send or receive messages.

Battery Status

- Full
- 2/3
- 1/3
- Low

Using Timeport P935 Application Screens

The Timeport P935 screens include several common elements that you will want to become familiar with. If you are accustomed to using traditional Windows-type software applications, you are likely already accustomed to using many of these functions.

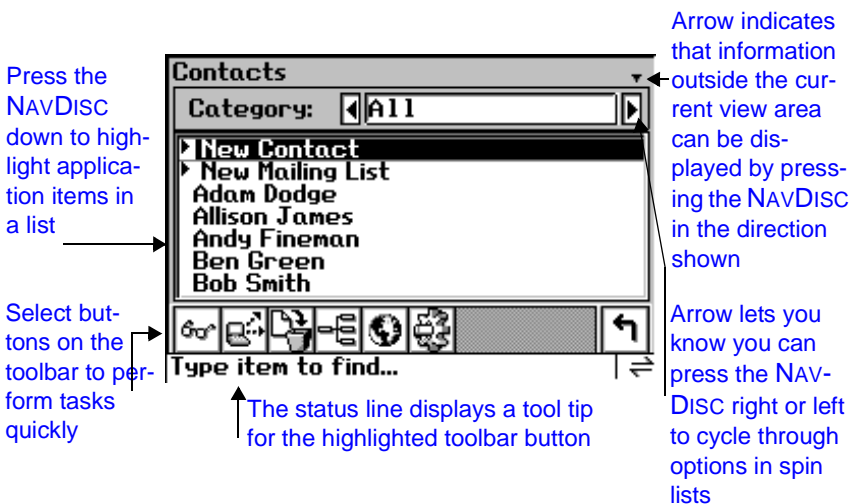

Several of the Timeport P935 applications use a tabbed interface to present a series of screens related to a particular function. To move between tabs, press the TAB key until the current tab icon is highlighted, then press the NAVDISC left or right to move to the next tab.

Press the NAVDISC left or right to move between tabs.

An underline beneath the arrow indicates you can select an option from a combo box or type your own information.

The screenshot shows a window titled "New Contact - Basic Information". At the top, there is a row of icons: a person, a phone, a hand, a computer, a printer, a briefcase, a house, and a star. Below this are four text input fields labeled "First name:", "Last name:", "Company:", and "Title:". The "Category:" field has a dropdown menu with "General" selected and a key icon to its right. At the bottom of the window, there are three icons: a checkmark, a document, and a question mark. To the right of these icons are two "ALT" keys and a return key icon.

Type data in text boxes using the QWERTY keyboard.

Highlight a check box and press ENTER to toggle the option on or off.

Move between tabbed screens by pressing the ALT key, then pressing the NAVDISC left or right.





The Battery and Charger

Motorola batteries and chargers are made from some of the highest-quality materials available. The battery and charger included with the Timeport P935 device come with a one-year limited warranty and should provide good performance well beyond the initial warranty period. However, rechargeable batteries do not last forever. At some point, batteries wear out and must be replaced.

Batteries, as well as other Motorola Timeport P935 accessories, can be purchased through your dealer, or by calling Motorola direct at 1-800-548-9954. For complete details on the limited warranty, see "Motorola Limited Warranty For Pagers" on page 157.

Determining the Battery Power

A status indicator at the bottom of the Home screen displays a four-level graphic indicator of the remaining power in the rechargeable battery.

-  **Full** — Approximately at full charge.
-  **2/3** — Approximately at two-thirds capacity.
-  **1/3** — Approximately at one-third capacity.
-  **Low Cell** — Almost drained of charge.

Recharging the Battery

Recharging can be accomplished by placing your Timeport P935 device in the charger or by removing the battery and placing only the battery in the charger. For optimum performance, use the recommended Motorola charger.

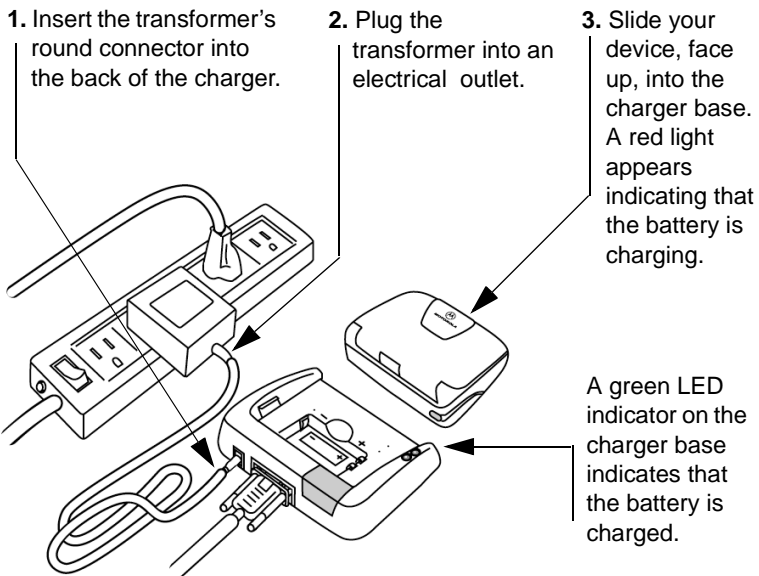

Before leaving on a trip, make sure the battery and any extra batteries are fully charged. Recharging the batteries to full charge should take about an hour or less per battery. All rechargeable batteries experience self-discharge, meaning that a small amount of energy discharges every day as a battery sits on the shelf.

Leaving the battery in the charger after the LED turns green keeps the battery charged until removed. Keep your spare battery charged by leaving it in your plugged-in charger.

Replacing the Battery

If your battery's performance has degraded (e.g., the battery's charge lasts only half as long as when it was new), consider replacing your battery with a new Motorola battery.

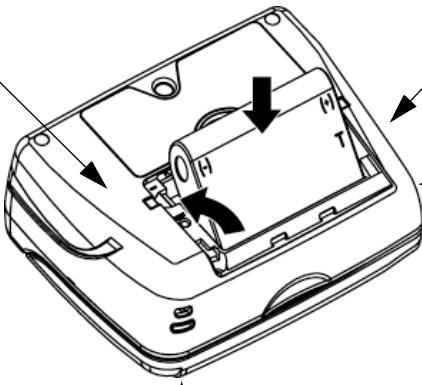
1. Turn the device over and slide the battery door in the direction indicated by the arrow on the door.
 2. Align the battery so that the gold contacts on the battery match the two contacts in the battery compartment.
 3. Insert the battery at an angle toward the outer edge of the device, making sure the white lift tab is below the battery. Press the battery into place.
 4. Slide the battery door back into place.
- 
- A line drawing of a Motorola Timeport P935 device with its battery door open. The device is shown from a three-quarter rear view. The battery compartment is visible, with two gold contacts. A battery is being inserted into the compartment. A white lift tab is visible on the battery. Arrows point to the battery door, the battery contacts, the battery insertion point, and the battery door being closed.

The Docking Station

The Timeport P935 device includes a charger base with an infra-red (IR) port. The charger base is used as a *docking station* for your device when transferring data to and from your computer or synchronizing your Timeport P935 PIM applications with your desktop PIM applications.

Connecting the Docking Station to Your Computer

The IR port in the docking station aligns with the IR port on your Timeport P935 device, enabling data transmission. The docking station is connected to your computer with the Motorola-provided RS232 null modem cable.

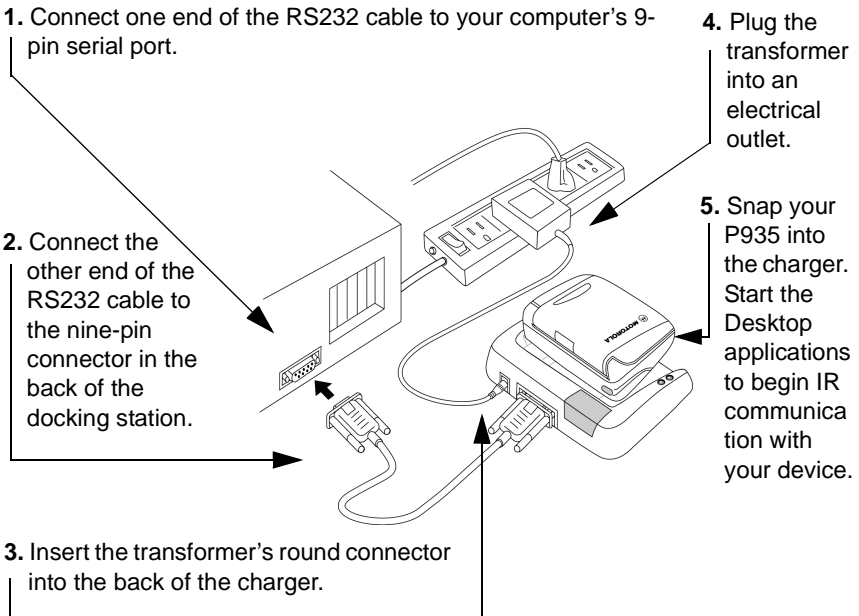

When a data transfer is in progress between the device and a PC, the green and red LED indicator lights on the Timeport P935 device will flash intermittently.

The Holster

The durable clip-on holster allows you to comfortably wear your Timeport P935 on your belt or pocket. The holster has been designed for your convenience and is not meant to secure your device under all circumstances. Additional accessories are also available. For more information, call 1-800-548-9954.

Turning your Timeport P935 Device On and Off

The rechargeable battery in your Timeport P935 device allows you to leave the device turned on 24 hours a day and, depending upon usage, can sustain operation for approximately a week before requiring a recharge. Turning your device off at night will lengthen the time of your battery's charge.

TIP *Incoming messages are stored by the messaging service until your device is turned on and ready to receive messages. Turn your device off at night when you do not want to receive messages, and place the device in the plugged-in charger so that it will be fully charged and ready for use the next morning.*

To turn on your device:

- ◆ Press any key

To turn off your device:

- ◆ Press ALT, HOME

Configuring Your Timeport P935 Device

The first time you start the device, the Welcome Tour appears. The tour helps you to become familiar with the basics of using your Timeport P935 device.

At the end of the tour, you are asked to perform the following setup tasks:

- Enter the correct time and date.
- Enter your signature so that it can be automatically appended to all messages you send.
- Enter your owner information so you can send it or beam it to other devices.

In addition, make certain the following are set correctly:

- Alert volume
- Transmit status

Setting Time and Date

Although your Timeport P935 comes pre-configured, you might need to set the correct time and date when you first receive your device. You can also set the display format for the time and date.

See Chapter 11, "Control Panel," for step-by-step instructions on setting the time and date.

Creating Your Signature

Signature enables you to create a signature that is automatically appended to each message you send.

See Chapter 11, "Control Panel," for step-by-step instructions on creating your signature.

Entering Your Owner Information

Your owner information is like an electronic business card. After you enter your owner information, you can send or beam that information to another compatible device in vCard format.

See Chapter 11, "Control Panel," for step-by-step instructions on entering your owner information.

Setting the Alert Volume Level

The Home screen displays the current volume level for alerts. You can set the alert volume level directly from the Home screen. Press TAB to move to the volume level indicator and press ENTER to choose from the following volume levels:



Loud - Sets all audible alerts to the loud volume.



Soft - Sets all audible alerts to the soft volume.



Vibrate - Sets all alerts to vibrate without changing the individual alert setting.



Silent - Sets the alerts without changing the settings.

Setting Transmit Status

Before attempting to send or receive messages, ensure your device is set to the proper transmission mode. The transmission mode controls whether you can send and receive messages.

When boarding an aircraft, set the radio transmitter mode to Off.

The Home screen displays the current transmit status. You can set the transmit status directly from the Home screen. Press TAB to move to the transmit status indicator and press ENTER to choose from the following:



2-WAY

2 Way - Lets you send and receive messages.



1-WAY

1 Way - Lets you receive, but not send messages.



OFF

Off - Disables message sending and receiving.

Setting Preferences

Preferences enable you to customize your device to suit your individual needs. You can set preferences for the whole device or for a specific application.

To set preferences that affect the whole device:

1. On the Home screen, select Control Panel.
2. Press the NAVDISC to move to the desired option, and then press the ENTER key.

See Chapter 11, "Control Panel," for step-by-step instructions on setting device preferences.

To set preferences that affect a specific application:

1. On the Home screen, select the desired application.
2. Select the Settings button from the toolbar.

Beaming Items

You can beam your owner information (vCard), other contact information, messages, and other items from your device to other compatible devices that have infrared ports, even printers.

When beaming to another device, make certain to aim the IR port on the back of your device to the IR port on the other device.

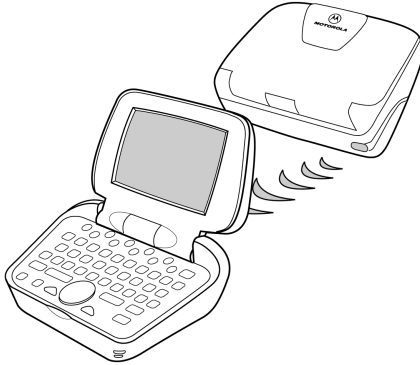

To beam your owner information:

- Press and hold the HOME key.

To beam an application:

1. On the Home screen, select Beam App.
2. From the list of applications, choose the application that you want to beam.
3. Select the OK button from the toolbar.

To beam contact information and other items:

1. From within any application, highlight the item you want to beam.
2. Select the Send item button.
3. On the Send slide-over, highlight either Beam to device, or Beam to printer, and then select the OK button.

Receiving Incoming Items

When you receive a message or other incoming item sent over-the-air or beamed to your Timeport P935 communicator, a pop-up similar to the following appears.

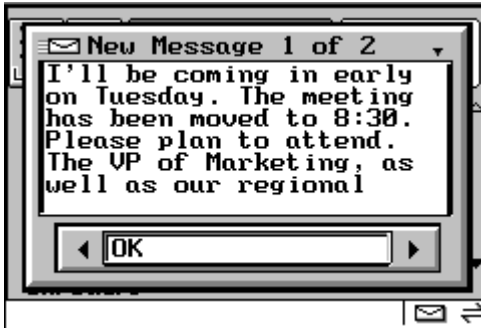

To scroll through the entire message:

- ◆ Press the NAVDISC up or down.

To perform an action on the message or item:

1. Press TAB to move to the spin list.
2. Press the NAVDISC left or right to display the desired option.
3. Press ENTER to perform the action.

When you are finished acting on the incoming message or item, the screen that you were viewing prior to receiving the new item redisplay.

Note: *If you reboot your device and you selected to run the Welcome application again after a reboot, you will not receive any new messages. Once you exit the Welcome application, two way messaging will resume.*

See Chapter 3, "Messages," for additional information about working with incoming messages.

The Timeport P935 device includes a number of common features that make the Personal Information Management (PIM) applications easier to use. Once you learn to use a feature in one application, you can be confident of how the feature will work in many of the other PIM applications. For example, many of the PIM applications included with your Timeport P935 device contain the following common features and functions:

- Categories
- Cut, Copy, and Paste
- Insert Text
- Send
- Private Entries

This chapter explains how to use these common features with any of the Timeport applications in which they are supported.

In addition, this chapter includes information about the following applications available from the Home screen:

- Trashcan
- Find
- Express
- Help

Using Categories

Several of the Timeport applications use categories to help you manage entries and track information. For example, you may assign all contact entries, mailing lists, memos, and tasks to a category. By organizing your entries in this way, you can quickly view and work with just those entries that pertain to a particular category.

Although your Timeport applications include several common categories, such as General, Business, and Personal, you can create custom categories to fit your individual needs.

You can also rename or delete most categories. You cannot, however, rename or delete the General category.

To add a category:

1. From the main Contacts, Tasks, or Memos screen, select the Categories button from the toolbar.
2. From the application Categories screen, select New Category.

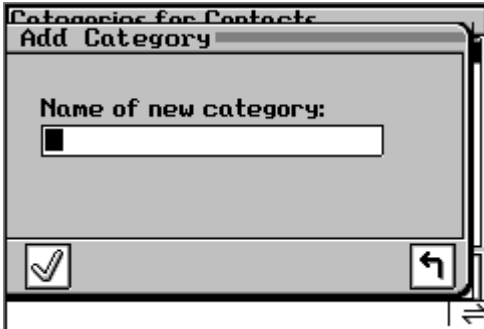

3. Type the name of the new category that you want to create.
4. Select the OK button from the toolbar.

To rename a category:

1. From the main application screen, select the Categories button.
2. From the application Categories screen, highlight the category name that you want to change

Note *You cannot rename the General category in any application, nor the Calls category in the Tasks application.*

3. Select the Rename category button from the toolbar.

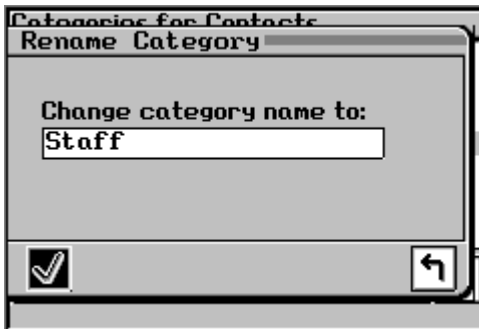

4. Change the category name.
5. Select the OK button from the toolbar.

To delete a category:

1. From the main application screen, select the Categories button from the toolbar.
2. From the application Categories screen, highlight the category name that you want to delete.

Note You cannot delete the General category in any application, nor the Calls category in the Tasks application.

3. Select the Delete category button from the toolbar.
4. If there are entries that belong to the category you are deleting, determine what to do with those entries. You can choose one of the following actions:
 - Put in trash
 - File under another category
 - Cancel the delete category action

Using Cut, Copy, and Paste

You can cut, copy, and paste information from Timeport messaging and PIM applications using the following hot keys.

Cut	ALT, X
Copy	ALT, C
Paste	ALT, V

To cut text from a field you can type in:

1. Position the cursor at the starting point of the text to be copied.
2. Press and then release the SHIFT key.
3. Use the NAVDISC to highlight the text.
4. Press the ALT key, then type **X** to cut the highlighted text. The text is deleted from the current text box and copied to the clipboard.

To copy text from a field you can type in:

1. Position the cursor at the starting point for the text that you want to copy.
2. Press and then release the SHIFT key.
3. Use the NAVDISC to highlight the text.
4. Press the ALT key, then type **C** to copy the highlighted text. The text is copied to the clipboard.

To copy text from a field you cannot type in:

1. Press the ALT key, then type **Z** to start highlight mode.
2. Position the cursor at the starting point for the text that you want to copy.
3. Press and then release the SHIFT key.
4. Use the NAVDISC to highlight the text.
5. Press the ALT key, then type **C** to copy the highlighted text. The text is copied to the clipboard.

To paste text into a field you can type in:

1. Position the cursor where you want to insert the copied text.
2. Press the ALT key, then type **V** to paste the highlighted text.

Inserting Text

To save you time when composing and editing messages, contact entries, calendar events, tasks, or memos, you can insert any of the following:

- Text from another Timeport application
- Current date and time
- Your signature
- Quick Text entries

To insert the current date/time, your signature, or Quick Text in Read, Contacts, Calendar, Tasks, or Memos:

1. Position the cursor at the point where you want to insert the text.
2. Select the Insert text button from the toolbar.

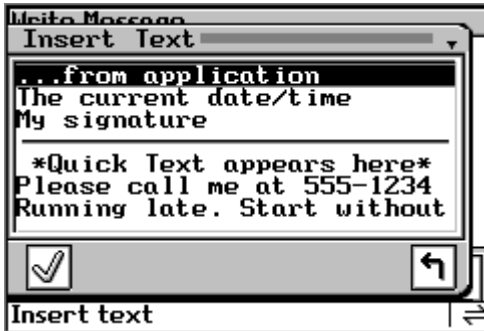

3. Using the NAVDISC, highlight one of the following:
 - The current date/time
 - My signature
 - A Quick Text entry
4. Select the OK button from the toolbar.

To insert text from an application:

1. Position the cursor at the point where you want to insert the text.
2. Select the Insert text button from the toolbar.
3. Select *...from application*.

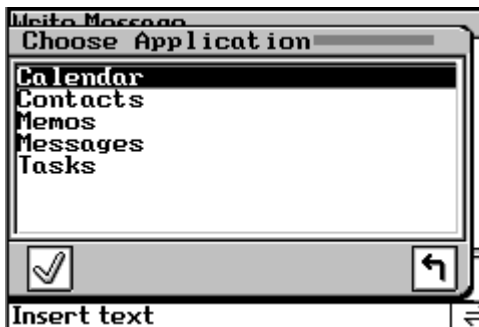

4. Highlight the application containing the text that you want to insert.

5. Select the OK button from the toolbar.
6. Narrow your search criteria by doing one of the following:
 - If you selected Tasks, Memos, or Contacts, choose the category for the item containing the text that you want to insert.
 - If you selected Calendar, choose the date of the calendar event containing the text that you want to insert.
 - If you selected Messages, choose the folder containing the message text you want to insert.
7. Using the NAVDISC, scroll through the list of items in the selected category, date, or folder and highlight the item containing the text that you want to insert.
8. Select the OK button from the toolbar.

Sending Information

The Personal Information Management (PIM) applications enable you to send contact entries, calendar events, tasks, and memos from your Timeport device to someone else using the Send function.

When you send information, you can choose to:

- Send an item over-the-air.
- Beam the information to other compatible devices that support infrared (IR) beaming.
- Beam the information to compatible printers that support infrared (IR) beaming.
- Beam an application category and all of its records to a compatible printer.

To send information as a formatted item:

1. From the Contacts, Calendar, Tasks, or Memos application, select the item that you want to send.
2. Select the Send button from the toolbar.
3. Select Send as contact, event, task, or memo, as applicable.

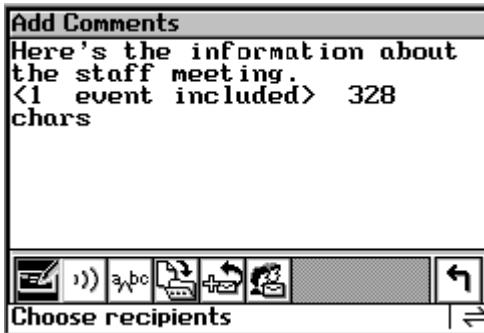

4. Type the message text that you want to accompany the item.
5. Select the Choose recipients button from the toolbar.
6. Using the NAVDISC, highlight the recipient name and the sendable address to which you want to send the message.
7. Select the Send message button from the toolbar.

To beam PIM information to a compatible device or printer:

1. From the Contacts, Calendar, Tasks, or Memos application, select the item that you want to beam.
2. Select the Send button from the toolbar.
3. Aim the IR port on the back of your device to the IR port on the other device or printer.
4. Select either Beam to device or Beam to printer.

To beam a category to a compatible printer:

1. From the Contacts, Calendar, or Tasks application, select the category (or day in Calendar) that you want to print.
2. Select the Send button from the toolbar.
3. Aim the IR port on the back of your device to the IR port on the printer.
4. Select Beam to printer.

Marking Private Entries

Many of the Timeport applications enable you to mark entries as private. If you mark an entry as private, you can control when the entry is visible using Privacy Options in Control Panel.



To mark items as private:

- When creating a new entry or editing an existing entry in your Timeport applications, select the *Private* check box.

To show or hide private entries:

1. Select the Control Panel application from the Home screen.
2. Select the Privacy Options icon.
3. Do one of the following:
 - To make all private items visible, choose Show.
 - To hide all items marked private, choose Hide.
4. Select the Save settings button from the toolbar.

Note: *When you move private entries on your device to a desktop PIM application during synchronization, the item is not marked as private on the desktop.*

If you move the item from the desktop PIM application back to your device, make certain to edit the item and select the Private check box to restore the private setting.

Using Trashcan

When you delete items on your Timeport P935 device, many of them are moved to the Trashcan before being permanently deleted. You can view the items in the Trashcan, permanently discard them, specify Trashcan settings that determine how often items in the Trashcan should be deleted, or recover items from the Trashcan and restore them to the originating application.

The following application items are moved to the Trashcan when deleted.

- Messages (Msg)
- Contacts (Ctct)
- Calendar events (Cal)
- Tasks (Task)
- Memos (Memo)
- Jukebox Alerts (Alrt)
- Calculator formulas (Form)
- Quick Text (Qtxt)

Items can be restored from the Trashcan until the Trashcan is emptied. The Trashcan is emptied whenever you request, when memory is low, or based on the settings that you assign.

To view items in Trashcan:

1. Select the Trashcan application from the Home screen.



2. Using the NAVDISC, scroll through the items in the Trashcan and highlight the item you want to view.

Note *The originating application associated with the deleted item displays on the left of the Trashcan list screen.*

3. Select the View item button from the toolbar.

To restore items from Trashcan:

1. Select the Trashcan application from the Home screen.
2. Highlight the item that you want to remove from the Trashcan and restore to its originating application.
3. Select the Restore item button from the toolbar. The main Trashcan screen is redisplayed without the restored item.

Note *If you restore messages and their corresponding folder was deleted, they are restored to the Inbox. If you restore items that belonged to a category that has been deleted, they are restored to the General category.*

To permanently delete all items in Trashcan:

1. Select the Trashcan application from the Home screen.
2. Select the Empty Trashcan button from the toolbar.



3. If you are sure you want to delete all items in Trashcan, select the OK button.

Caution *Items deleted from the Trashcan cannot be recovered.*

4. The main Trashcan screen is redisplayed without any items.

To specify Trashcan settings:

1. Select the Trashcan application from the Home screen.
2. Select the Settings for Trashcan button from the toolbar.

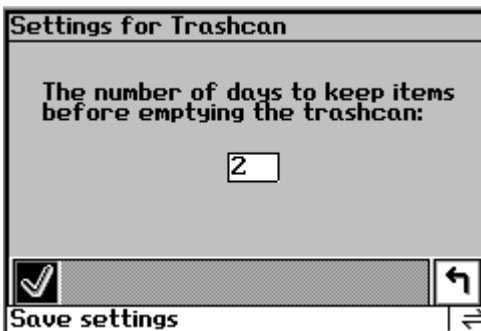

3. Type the number of days that you want deleted items to remain in the Trashcan before they are permanently discarded.
4. Select the OK button from the toolbar to save your settings and return to the main Trashcan screen.

Using Find

Find enables you to search for words or phrases from within or across any of the Timeport PIM applications and the messaging applications. Find searches through the data contained in your applications and returns a list of all entries, by application, that contain the text you specified.

To find a word or phrase:

1. Select the Find application from the Home screen.

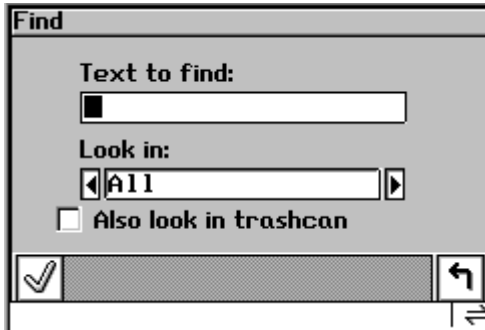

2. In the Text to find box, type the text that you want to search for. The search is not case sensitive.
3. From the Look in field, select the application that you want to search. You can search any or all of the following Timeport applications:
 - Calendar
 - Contacts
 - Memos
 - Messages
 - Tasks
4. If you want Find to also search through any deleted items in the Trashcan, select the Also look in Trashcan option.
5. Select the Find now button from the toolbar. Find searches for the text you requested and displays, by application, the number of items matching the word or phrase you specified.

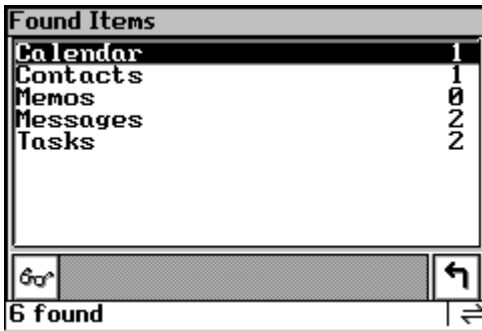

- Review the list of applications containing found items and select the application whose items you want to view.

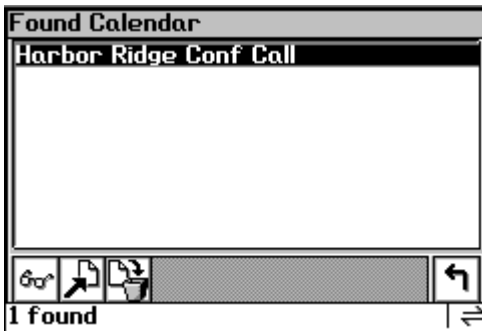

- To view the details for a found item, highlight the item and select the View item button from the toolbar.

TIP To close the Find application and open the application associated with a found item, select the Go to item toolbar button. The associated application will open with the found item displayed in View mode.

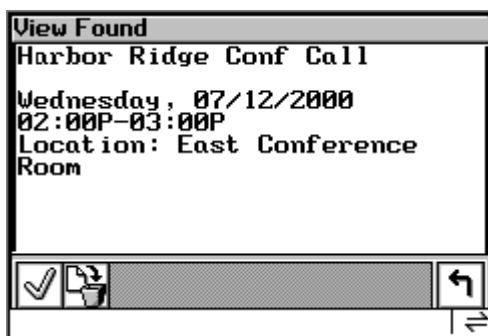

8. When you are finished reviewing the item, press the HOME key to return to the Home screen.

Using Express

The Express application enables you to quickly send information to recipients over-the-air or to beam information directly to other compatible devices and printers that support infrared (IR) beaming.

The information you can send or beam to other users includes:

- Your owner information (known as a vCard when beamed).
- A message.
- A calendar event (known as vCalendar when beamed).
- Contact information from Contacts.
- A to-do from Tasks.
- A note from Memos.
- An alert from Jukebox.

To quickly beam or send other information:

1. Select the Express application from the Home screen.

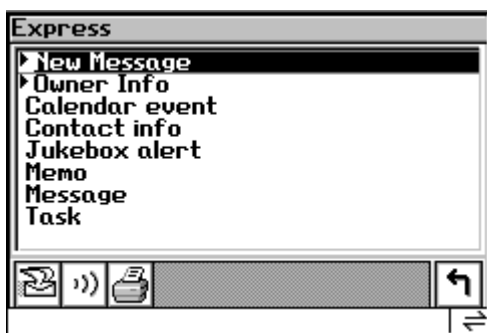

2. Highlight the information type you want to send.

Note *If you choose New Message, the Compose Message screen appears. See "Creating and Sending New Messages" on page 51 for additional information.*

3. Select one of the following buttons from the toolbar.
 - Send item
 - Beam item
 - Print item
4. From the Choose an *item* pop-up for the information type you selected, narrow your search criteria by doing one of the following:
 - If you selected Contact info, Memo, or Task, choose the category for the item that you want to send.
 - If you selected Calendar event, choose the date of the scheduled event that you want to send.
 - If you selected Message, choose the folder containing the message text you want to send.
5. Using the NAVDISC, scroll through the item list and highlight the item that you want to send.
6. Select the OK button on the toolbar.
7. Do one of the following:
 - If you chose to send the item to recipients, from the Send *item* to screen, highlight the contact name of the person to whom you are sending the item and select Send.
 - If you chose to beam or print the item, aim the IR port on the back of your communicator to the IR port on the other device or printer.

Using Help

To assist you with learning certain features and functions of the Timeport applications, an online Help application is available from the Home screen. You can also access certain help topics directly from the application with which they are associated by selecting the Help button on the toolbar.

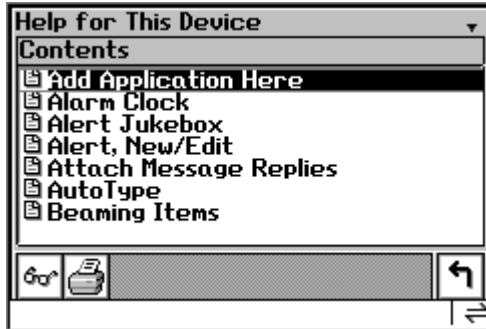

Read and Write provide many of the same robust features you are accustomed to using in desktop e-mail messaging applications.

Using Read, you can:

- View, forward, and file incoming messages or reply to them using stored responses or custom replies that you compose.
- Reply to multiple recipients.
- Manage your Inbox, Draft folder, Sent folder, and Outbox from the Message Area.
- Create personal message folders to receive specific types of messages.
- Create message rules that enable you to specify routing and alert options for messages meeting the rule criteria you set.
- Set preferences for incoming messages including timed alert reminders.

Using Write, you can:

- Compose messages using the QWERTY keyboard and choose to send the message immediately or delay sending until later.
- Compile a list of favorite contacts to whom you send messages most often. Later, when you compose a message, you can quickly select a recipient from the list.
- Create and attach a selection of canned replies to messages you compose. Your message recipients can then quickly select an appropriate response from the list you provide.

Messages can be sent to other compatible personal interactive communicators (PICs), smart pagers, two-way pagers, one-way pagers, e-mail addresses, and fax numbers.

Receiving New Text Messages

When a new message arrives, a New Message pop-up displays to alert you that you have received a new message. You can choose to read the message when it arrives, reply to the message, delete the message, or dismiss the message without taking any action.



To respond to a New Message alert:

- When the New Message pop-up appears, choose one of the following options for the new message:

OK	Marks the message as read. If you have more than one new message, the next message displays. Otherwise, closes the pop-up.
Reply	Displays the Choose Reply pop-up. (See "Replying to Messages" on page 57.)
Put in trash	Moves the message to the Trashcan. (See "Using Trashcan" on page 40.)
Remind me later	Reminds you of the unread message based on the time interval you specify in Settings for Read. (See "Setting Message Preferences" on page 67.)
Exit	Closes the New Message pop-up and leaves the message marked as unread.

About Write

Using Write, you can do the following:

- Compose and send messages.
- Schedule your messages to be sent later.
- Set preferences for the messages you compose.

Creating and Sending New Messages

The QWERTY keyboard provides a familiar key layout, enabling you to quickly type and send your message.

To compose and send a message:

1. Select the Write application from the Home screen.
2. Type your message.

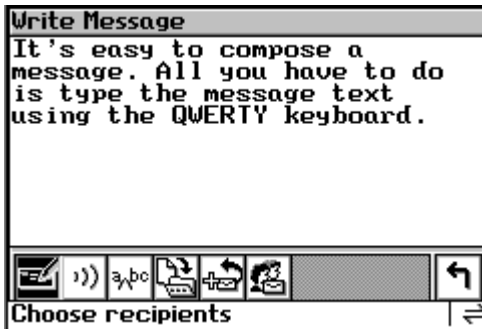

3. If you want to provide a selection of replies from which your message recipient can select a response to your message, select the Add replies button from the toolbar. See "Attaching Message Replies" on page 55.
4. When you are finished composing a message, select the Choose recipients button from the toolbar.

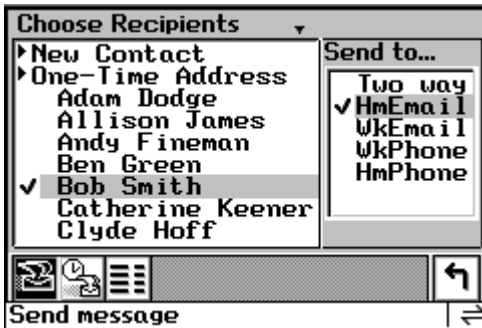

5. From the Choose Recipients list, highlight the name of the contact to whom you are sending the message.
6. With the contact name highlighted, press the NAVDISC right to sequence through the Send to... addresses for the contact entry. Choose the address that you want to use for this mes-

sage and press the SELECT key. A checkmark appears to the left of the selected address.

7. Select the Send message button from the toolbar.

Entering a One-Time Address

On occasion, you may want to send a message to an individual one time only. Since you don't anticipate ever sending a message to the recipient again, you may not want to add them to your contact list.

To enter a one-time recipient address:

1. Compose a message as described above and select the Choose recipients button from the toolbar.

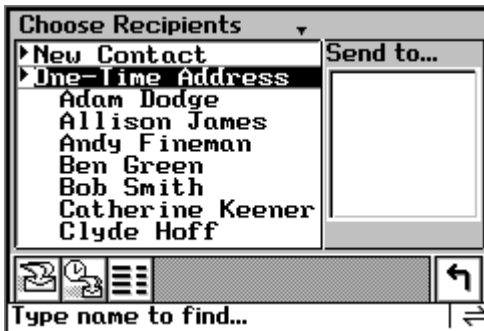

2. Select One-Time Address.

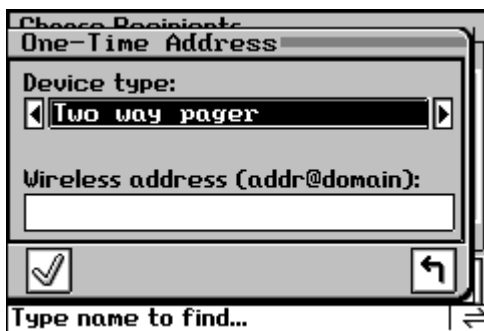

3. In the Device type field, select the device type.
4. Type the wireless address for the recipient.
5. Select the OK button from the toolbar.

Scheduling a Delayed Send

Messages and message replies can be composed at your convenience and then scheduled for automatic transmission at a later time. When you choose the recipients for your message, you can specify the delay sending options for the message.

To schedule a delayed message send:

1. On the Choose Recipients screen, select the Delay sending button from the toolbar.

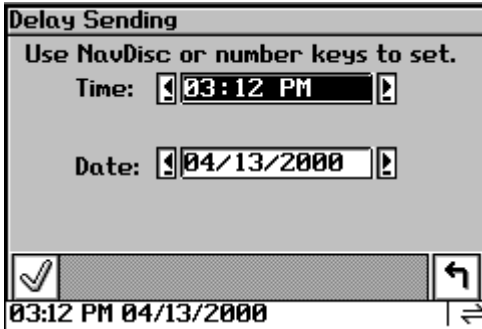

2. In the Time field, type the time when you want to send the message.

TIP Press the NAVDISC left or right in either the Time or Date field to increment or decrement the time and date.

3. In the Date field, type the date you want to send the message.
4. Select the OK button on the toolbar to accept the schedule.

Creating a List of Favorite Recipients

You can compile a list of the contacts or mailing groups to whom you send messages most often. You can then sort this list of contacts so that you can quickly select message recipients, by number, from a Favorites List rather than searching through the Choose Recipients list in the Contacts application.

To create a list of favorite recipients:

1. Select the Write application from the Home screen.
2. Select the Edit favorites button from the toolbar.



3. Select Add Address to List.
4. From the Add to Favorites screen, select a contact to appear on your Favorites List.
5. Repeat steps 3 and 4 for each contact you want to add to the list.

TIP If you want to rearrange the list of contacts, highlight a contact name and then select the Move up or Move down button to change the position of the contact in the list.

6. Select the OK button from the toolbar to save your favorites list.

To compose and send a message using Favorites:

1. Select the Write application from the Home screen.

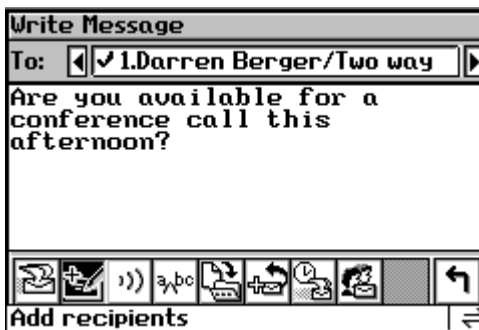

2. Type your message.
3. Press TAB to move to the To field.

4. Press the NAVDISC right to locate the recipient(s) for your message.
5. Press the SELECT key when the desired recipient's name appears. A check mark next to their name indicates that they are a selected recipient for the message.
6. Select the Send button from the toolbar to send the message to the recipients you selected.

Attaching Message Replies

When sending a message to a two-way messaging device that returns canned text responses, your Timeport P935 device allows you to provide a selection of replies to your message. Messages typed in the Replies fields will be available to the person receiving your message. Rather than selecting the standard messages available on their device, they can select one of the customized replies you have provided.

You can attach message replies to messages you compose or to a reply message that you send in response to a received message.

Note *This option appears only if your paging carrier supports attached replies.*

To attach message replies:

1. From the Write Message screen, select the Add replies button from the toolbar.

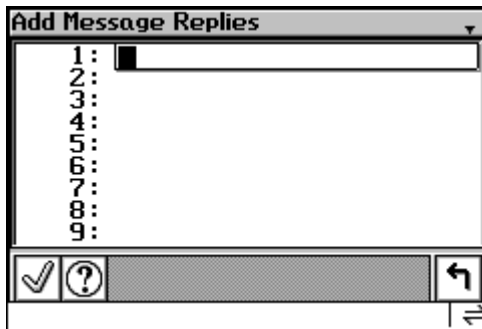

2. Type your choices of replies in the numbered fields.

TIP Fields are provided for sixteen replies. Use the NAVDISC to scroll down through the remaining numbered fields.

3. Select the Save replies button from the toolbar to attach the replies to your message when it transmits.

About Read

Messages you receive are stored in system folders or in personal folders that you create. You can choose to respond to a message when it first arrives, or to store it in a folder so that you can work with it later.

You access your stored messages through the Read application. Once you locate a stored message, you can do the following with the message:

- View the message
- Reply to the message
- Forward the message
- Move the message to another folder
- Delete the message

For more information about working with message folders, see "About Folders" on page 59.

Reading Messages

Incoming messages can be read when they are first received, or stored in the appropriate folder to be read at a later time.

To read a stored message:

1. Select the Read application from the Home screen.
2. Select the folder containing the message.
3. Select the message.
4. Select the OK button from the toolbar to return to the Messages list, or press the HOME key to return to the Home screen.

Replying to Messages

Responding to messages is quick using system-provided standard replies, Quick Text replies you create, or custom replies you type using the QWERTY keyboard.

To send a custom reply:

1. On the Messages screen, select the Reply button from the toolbar.
2. From the Choose Reply screen, select Compose Reply.

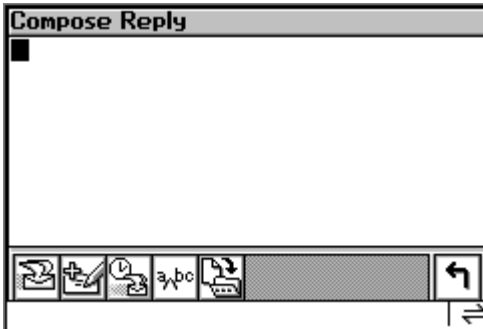

3. Type your response, then select the Send button from the toolbar. The Sending Reply pop-up appears.

To send a Quick Text reply

1. On the Messages screen, select the Reply button from the toolbar.
2. From the Choose Reply screen, select Quick Text Replies.



3. Highlight the reply you want to send.

4. Select the Send reply button from the toolbar. The Sending Reply pop-up appears.

Forwarding Messages

Your Timeport P935 device enables you to share your received messages without retyping them. Simply forward the message to an address in Contacts. Your signature is inserted at the beginning of the forwarded message.

To forward a message:

1. Open the message you want to forward.
2. Select the Forward message button on the toolbar.
3. (Optional) Write a comment or explanation above the original message or document.
4. Select the Choose recipients button on the toolbar and locate the contact to whom you want to forward the message.
5. Send the message.

Moving Messages to Folders

To help you manage the mail that you send and receive, you can move messages into folders you create.

To move a message to a folder:

1. From the Folder view or Message view, select the Move message button from the toolbar.

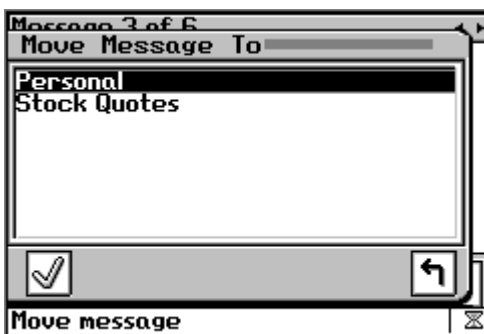

2. Choose the folder where you want to store this message.
3. Select the OK button from the toolbar.

Deleting Messages

Messages can be deleted from either a folder view or a message view. Deleted messages are moved to the Trashcan, where they are permanently erased when the Trashcan is emptied. For more information, see “Using Trashcan” on page 40.

To delete a message from a Folder view:

1. From the Folder list, highlight the message to be deleted.
2. Select the Put in trash button from the toolbar.

Note *To delete all read messages in the Inbox, select the Put all read messages in trash button from the toolbar.*

To delete a message from a Message view:

- From the Message view, select the Put in trash button from the toolbar.

About Folders

If there are unread messages in any of the folders, a star appears to the left of the icon, and the number of unread messages in parentheses follows the name of the folder.



The Inbox automatically stores all messages that you receive, until you move them to another folder or delete them.



The Information Services folder automatically stores all messages that you receive from Information Service providers. (This network dependent feature is not available in all areas.)



The Drafts folder stores unfinished or partially composed messages that haven't been sent yet.



The Outbox contains all messages that you have attempted to send, but that have not yet been sent successfully. Once the status of a message changes to Sent, it is moved to the Sent folder.



The Sent Messages folder contains all messages that have been sent successfully.



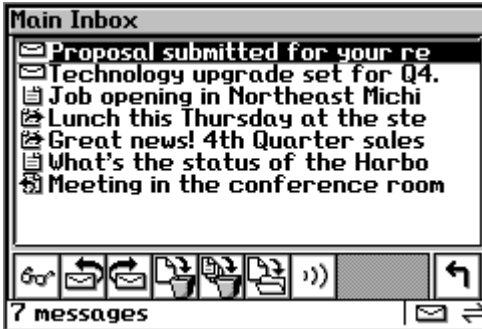

You can have up to 200 folders, including system folders. See “Creating New Folders” on page 63 for more information.

About the Inbox

The Inbox receives incoming messages transmitted to your Timeport P935 device.



Messages that appear in the Inbox can have one of the following four conditions:

-  The message has not been read.
-  The message was replied to.
-  The message was forwarded.
-  The message was read.

Unread messages appear at the top of the list, followed by replied to, forwarded, and read messages.

Additional folders that you create provide the same view and functions as the Inbox.

About the Drafts Folder

The Drafts folder contains partial or unfinished messages that you save for later editing and transmission.

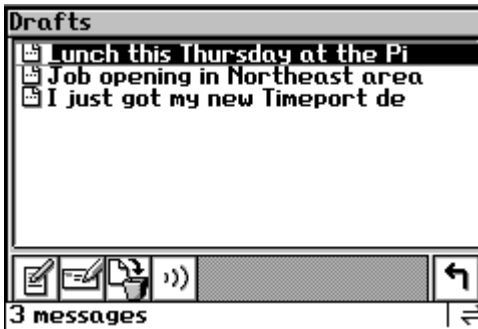

When a message in the Drafts folder is opened, the Compose Message screen is displayed so that you can edit or complete the message.



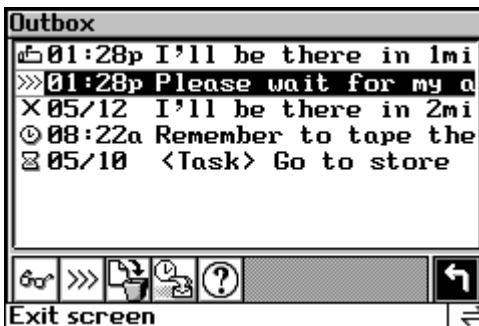

About the Outbox

The Outbox acts as a holding area for unsent messages.



Items in the Outbox are sorted by date and time, with the most recent message appearing first. If the message was sent today, the time appears next to the message; otherwise, the date the message was sent appears.

Messages that appear in the Outbox are categorized into five types:

-  The message is waiting to be sent.
-  The message is being sent.
-  The message send failed.
-  The message will be sent later based on the delayed send time you specified.
-  The message could not be sent because the transmitter is off or you are out of range, but will be sent again as soon as possible.

Once the message is sent successfully, the message is moved to the Sent Folder.

About the Sent Messages Folder

The Sent Messages folder stores all messages that were sent successfully.

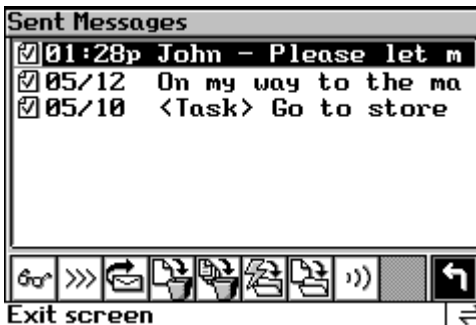

Items in the Sent Messages folder appear in the order in which they were sent, most recent at the top. If the message was sent on the current day, the time appears after the Sent Successfully status icon. Otherwise, the date appears.

You can add the text of a sent message to the Quick Text database so that it can be used as a Quick Text reply.

All sent messages remain in the Sent Messages folder until a scheduled cleanup of the folder takes place or until you delete them.

Working with Folders

You can create, rename, and delete personal folders at any time. You cannot, however, delete or rename system folders. But you can change cleanup options for either personal or system folders any time you choose.

Creating New Folders

You can create personal folders to receive specific types of messages. Incoming messages are automatically routed to your personal folder based upon routing rules that you define.

To create a new folder:

1. Select the Read application from the Home screen.
2. Select the New folder button from the toolbar.

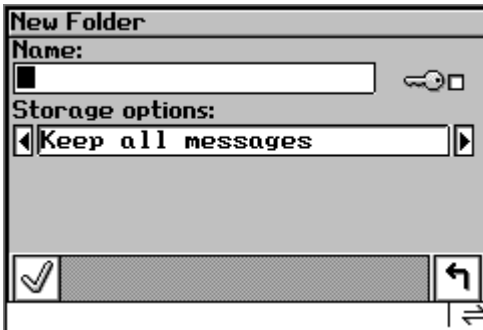

3. Type the name of the new folder in the Name field.
4. If you want to make this a private folder, select the Private check box.
5. Select one of the following storage options for the folder:
 - Keep all messages
 - Discard messages older than the number of days you specify
 - Set folder limit to store only the number of messages you indicate
6. Select the OK button from the toolbar.

To edit a folder:

1. Select the Read application from the Home screen.
2. Highlight the folder that you want to modify.

3. Select the Edit folder settings button from the toolbar.

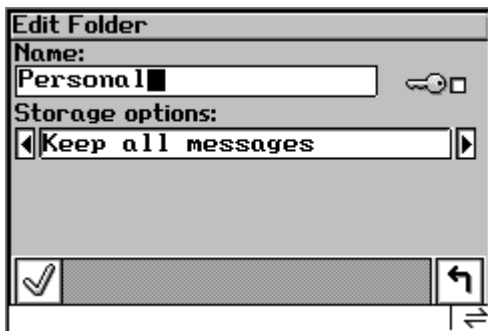

4. Modify the folder name and storage options, as applicable.

Note You cannot rename system folders.

5. Select the OK button from the toolbar to save your changes.

To delete a personal folder:

1. Select the Read application from the Home screen.
2. Highlight the personal folder that you want to delete.

Note You cannot delete the *Inbox*, *Outbox*, *Sent Messages* folder, or *Draft* folder.

3. Select the Delete folder button from the toolbar. The following screen displays.



4. Choose one of the following options:
 - Save messages in Inbox
 - Put messages in trash
 - Cancel delete action

About Message Rules

The Message Rules feature enables you to set routing rules and message alert options for incoming messages that contain specific keywords or text strings you specify. When incoming messages arrive, your Timeport P935 device looks to see whether the message meets the rule criteria. If so, the message is routed to a folder you specify and the appropriate alert sounds.

Message rules appear in the Message Rules list as shown below.

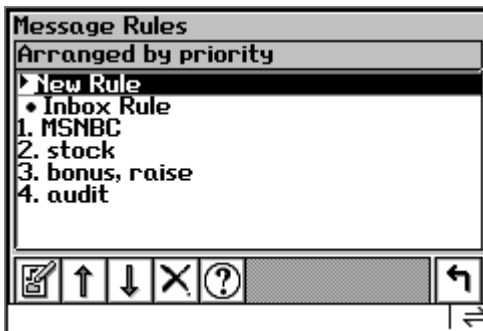

The keywords associated with the rule are displayed as the name of the rule. Each rule in the list is preceded by a number indicating its priority. The priority determines the order in which the rule is executed when a new message arrives. You can change the message priority by moving the rule up or down in the list.

Creating Message Rules

When you create a new rule, you specify the text that you want your device to look for when incoming messages arrive, specify the folder where you want to place messages meeting the rule criteria, and make decisions about how you want to be alerted when messages arrive that meet the rule criteria.

To create a message rule:

1. Select the Read application from the Home screen.
2. Select the Message rules button from the toolbar.

3. Select New Rule.

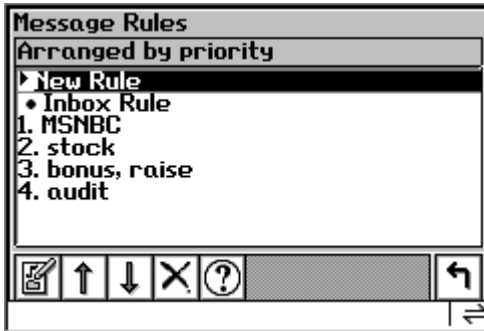

4. In the If message contains text box, type the rule text.
5. In the Store in field, select the folder where you want to store messages that meet the rule.
6. In the Play field, select the alert that you want to sound when you receive incoming messages matching this rule.
7. If you want the specified alert to override the device settings for silent mode, vibrate mode, or Quiet Time settings, select the Play regardless of volume level option.
8. If you want to receive alert reminders every two minutes for unread messages meeting this rule, select the Beep until read option.
9. If you want incoming messages meeting this rule to appear in a New Message popup box, select the Display pop-up when received option.
10. Select the Save rule button from the toolbar to save the new message rule.

Editing Message Rules

You can change routing rule options for incoming messages any-time.

To edit a message rule:

1. Select the Read application from the Home screen.
2. Select the Message rules button from the toolbar.
3. On the Message Rules list, highlight the message rule you want to modify.
4. Select the Edit rule button from the toolbar.

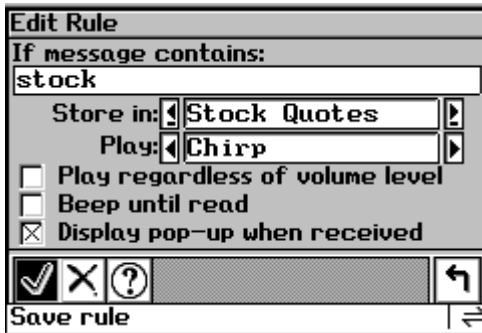

5. Change the message rule options as appropriate.
6. Select the Save rule button from the toolbar to save your changes.

Deleting Message Rules

You can delete any of the message rules you create at any time; however, if you delete an information service rule, it is automatically re-created the next time you receive an information service message.

To delete a message rule:

1. Select the Read application from the Home screen.
2. Select the Message rules button from the toolbar.
3. On the Message Rules list, highlight the message rule you want to delete.
4. Select the Delete rule button from the toolbar.

Setting Message Preferences

The Message Settings feature enables you to specify message alert and reminder options for received messages.

Using Message Settings, you can select to receive alert reminders every two minutes about messages that were not read at the time they arrived and continue to be unread.

To set message preferences:

1. Select the Read application from the Home screen.
2. Select the Settings for Read button from the toolbar.

3. If you want the message to show the time it was received, select the Display time of arrival option.
4. If you want to receive alert reminders about unread messages, select the Display new message pop-up option.
5. In the For unread messages field, select one of the following reminder options:
 - Beep for the number of hours you specify
 - Beep until read
 - No reminder beep
6. The New Message pop-ups enables you to choose to be reminded later of the incoming message. Specify the delay time interval for this message reminder in the Reminder me later spin box. You can choose any of the following:
 - 5 minutes
 - 10 minutes
 - 15 minutes
 - 30 minutes
 - 45 minutes
 - 1 hour
 - 2 hours
7. Select the Save settings button from the toolbar to save your message settings.

Using Common Timeport P935 Features with Read and Write

Read and Write enable you to use a number of common Timeport P935 features, including the following:

- Cut, copy, and paste text from other messages or Timeport P935 PIM applications.
- Insert text from another message or a Timeport P935 PIM application.
- Beam message information to another compatible device or printer that supports IR communication.
- Restore deleted messages from the Trashcan, if the Trashcan has not been emptied since the item was put in trash.

For more information about using these common features, see Chapter 2, "Using Common Features."

The Contacts application is a convenient electronic address book that enables you to store contact information about your personal and business contacts.

Using Contacts, you can:

- Enter up to five telephone numbers and e-mail addresses, plus home and work addresses, fax numbers, and device information for each contact entry.
- Record up to four additional pieces of information about each contact, such as spouse name, birthday, or whatever is important to you.
- Attach notes that provide additional information about your contacts.
- Organize your contact entries into categories so that you can quickly locate them based on category, such as business contacts or personal contacts.
- Organize contacts into groups, called mailing lists.

Entering Contacts

You can enter contact information for individuals and businesses. You can even organize your contacts into groups and establish mailing lists so that you can quickly send messages to an entire group of individual contacts at one time.

To enter a contact:

1. Select the Contacts application from the Home screen.
2. Select New Contact.

3. Type the contact's first name, last name, company name, and title in the appropriate fields.

Note *If you enter a contact, but do not specify a first, last, or company name, the contact will appear at the top of the Contacts list and the Choose Recipients list as "unnamed."*

4. In the Category field, choose a category for the contact.

TIP *You can also create a new category for a contact. See "Using Categories" on page 33 for more information.*

5. To make this a private contact entry, select the Private check box.
6. (Optionally) Enter the following additional information for this contact entry:
 - Device type and wireless address
 - Main, work, home, mobile, and alternate telephone numbers
 - Main, work, home, alternate, and web e-mail addresses
 - Home and work fax number
 - Work address
 - Home address
 - Up to four additional pieces of information for the contact

TIP To move between tabs, highlight the current tab icon and press the NAVDISC left or right. Press ALT-NAVDISC to move between tabs when the tab icon is not highlighted.

7. To record notes about the contact, select the Notes button from the toolbar.
8. When you are finished recording information about this contact, select the Save contact button from the toolbar.

Editing a Contact Entry

Address information saved in Contacts can be updated as information changes.

To update Contact entries from your personal computer, use the PC Partner Desktop application. The application includes online help with step-by-step instructions for completing this task.

You can also update contact entries from your Timeport P935 personal interactive communicator.

To edit a contact entry:

1. Select the Contacts application from the Home screen.
2. From the Category field, choose the category of the contact whose address information you want to edit.
3. Using the NAVDISC, scroll through the list of contacts and highlight the contact name.

TIP Type the first several characters of the contact name to quickly scroll to the names beginning with those characters.

4. Select the View item button from the toolbar.
5. Select the Edit contact button from the toolbar.
6. Edit the information for the contact.
7. Select the Save contact button from the toolbar to save your changes and redisplay the main Contacts screen.

Deleting Contact Entries

A well-maintained address book provides quick access to the contact information you need. Delete contact entries for individuals or businesses that you no longer contact.

You can delete contacts from your Timeport P935 device in either of the following ways:

- Delete a contact entry directly from the main Contacts screen.
- Delete a contact entry after opening and reviewing it in the View Contacts screen.

Caution Deleted addresses cannot be recovered.

To delete contacts from the main Contacts screen:

1. Select the Contacts application from the Home screen.
2. From the Category field, choose the category of the contact that you want to display. If you want to see all of the contacts that you have entered, change the category to All.
3. Using the NAVDISC, scroll through the list of contacts and highlight the contact that you want to delete.
4. Select the Put in trash button from the toolbar. The main Contacts screen reappears without the contact.

To review and then delete a contact:

1. Select the Contacts application from the Home screen.
2. From the Category field, choose the category of the contact that you want to display. If you want to see all of the contacts that you have recorded, change the category to All.
3. Using the NAVDISC, scroll through the list of contacts and highlight the contact that you want to delete.
4. Select the View item button from the toolbar.
5. Review the contact and then select the Put in trash button from the toolbar. The main Contacts screen reappears without the contact.

Looking up Contact Entries

When you open the Contacts application from the Home screen, the main Contacts screen displays all of your contact entries in alphabetical order.

Note *Whether the entries are sorted by last name, first name, or company name depends on the settings you choose in Contacts Settings. See "Setting Contact Preferences" on page 74.*

To scroll through the list of contacts, use the NAVDISC. To quickly scroll to a specific contact, type the first few characters of the contact name. To see all of the address information available for the contact, use the following procedure.

To look up contact information:

1. Select the Contacts application from the Home screen.
2. From the Category field, choose the category of the contact or mailing list for whom you want to look up address information.

TIP *Type the first several characters of the contact name to quickly scroll to the names beginning with those characters.*

3. Using the NAVDISC, scroll through the list of contacts and highlight the contact entry you want to view.
4. Select the View item button from the toolbar.



TIP *If this entry contains more contact information than can be displayed on one screen, press the NAVDISC down to display the remaining information.*

5. Select the OK button from the toolbar to return to the main Contacts screen.

Setting Contact Preferences

You can choose to sort contacts by last name, first name, or company name. If a contact entry does not contain the name you choose to sort by, the contact entry is sorted by the next available name.

For example, if you choose to sort by last name, then first, and the contact entry does not include a last name, the entry is sorted alphabetically by first name. If the contact entry does not contain a first name either, the company name is used to determine the sort order.

The following chart shows the order for determining which name is used for sorting:

Choose...	To sort the contact list alphabetically by...
Last, First	If the contact entry does not include either last or first name, the company name is displayed.
First, Last	The company name does not display in the sort list, unless it is the only name available for the entry.
Company, Last	The first name does not appear in the sort list, unless it is the only name available for the entry.

Contacts provides four custom fields that you can rename to identify additional information about your contact entries. This enables you to record information such as spouse name, birthday, anniversary, or whatever information you choose to record for your contact entries.

To set contact preferences:

1. Select the Contacts application from the Home screen.
2. Select the Settings for Contacts button from the toolbar.

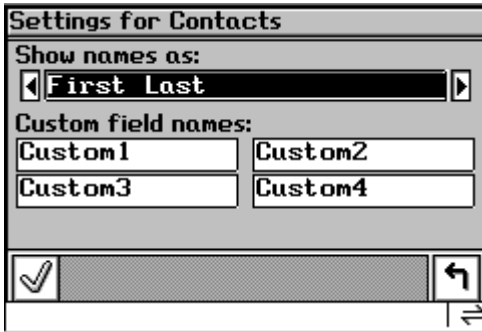

3. Choose the format to use when showing contact entries. You can choose one of the following options:
 - Last, First
 - First Last
 - Company, Last
4. Rename all four of the Custom field names with field names of your choice.
5. Select the Save settings button from the toolbar.

Creating a Mailing List

If you frequently send messages to the same group of contacts, you can create a mailing list to make it easier to address messages to the group. Instead of addressing the message to each contact individually, you can address the message to the mailing list.

To create a mailing list:

1. Select the Contacts application from the Home screen.
2. Select New Mailing List.

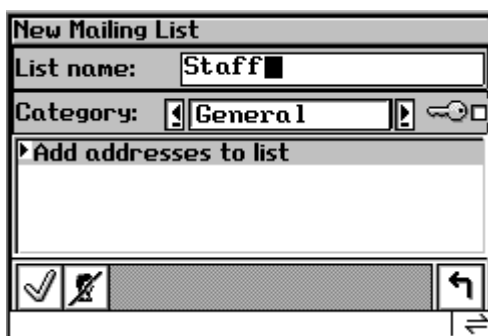

3. In the List name field, type the name for the mailing list as you want it to appear in the Contacts list.
4. In the Category field, choose a category for the mailing list.

TIP You can also create a new category for a mailing list. See "Using Categories" on page 33 for more information.

5. To make this mailing list entry private, select the Private check box.
6. Select Add Addresses to List.

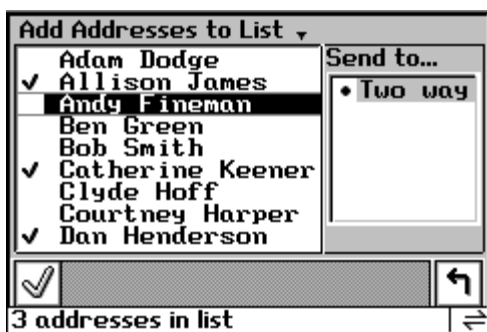

7. Highlight the first contact name that you want to include in the mailing list.
8. With the contact name highlighted, press the NAVDISC right to sequence through the Send to... addresses for the contact entry. Highlight the address that you want to use for this contact and press the SELECT key. A checkmark appears to the left of the selected address.

TIP You can choose multiple addresses for a contact.

9. Repeat steps 7 and 8 for each contact you want to include in the mailing list.
10. When you are finished adding contacts to the list, select the Save mailing list button from the toolbar to save the mailing list.

Using Common Timeport P935 Features with Contacts

Contacts enables you to use a number of common Timeport P935 features, including the following:

- Define new categories for organizing your contact entries and mailing lists into logical groups.
- Cut, copy, and paste text from other contact entries, mailing lists, Timeport P935 PIM applications, or the clipboard.
- Insert text from another contact entry or Timeport P935 PIM application.
- Beam contact or mailing list information to another device or printer that supports IR communication.
- Restore deleted contacts from the Trashcan, if the Trashcan has not been emptied since the item was put in trash.

For more information about using these common features, see Chapter 2, "Using Common Features."

Calendar enables you to record appointments, meetings, birthdays, anniversaries, and other events that you don't want to forget.

Using Calendar, you can:

- Create calendar entries for scheduled appointments, all-day events, or special days.
- View your appointments for a specific date or see all calendar events for an entire week or month at a glance.
- Create recurring events for appointments that repeat.
- Set Calendar preferences, including a default view and event reminder options.
- Beam your calendar events, or vCalendar entries, to other compatible hand-held devices or printers that support IR communication.

Viewing Events

Calendar has three different views from which you can choose. You can easily navigate between these views or go directly to a specific calendar date.

TIP To view calendar entries for a specific day, select the *Jump to date toolbar button* from any calendar view.

Use the following toolbar buttons to navigate between the views:



Day View



Week View



Month View

Using Settings for Calendar, you can set preferences for which view you want to use as the default when you open the Calendar application.

Day View

This view displays a list of appointments for a specific date with a single timeline column showing appointments and conflicts. Press the NAVDISC left or right to view the next or previous day.

All-day events display as a light gray bar.

Special days are noted with an asterisk (*).

Appointments display as a medium gray bar.



Appointment conflicts are shown as a black bar inside the medium gray bar.

Week View

A weekly view shows seven timeline columns, with appointment blocks in gray and conflicts in black.

Special days are displayed with a star below the weekday name.

All-day events are displayed as a light gray bar.

Appointments display as a medium gray bar.

Use the NAVDISC to move between day tabs.

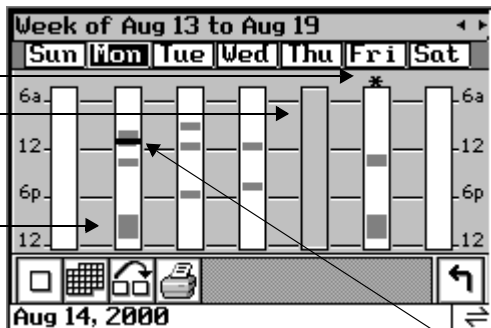

Appointment conflicts are displayed as a black bar inside the medium gray bar.

Month View

This view displays a monthly calendar that uses various symbols to indicate scheduled events. Press the NAVDISC left or right to move between days and months.

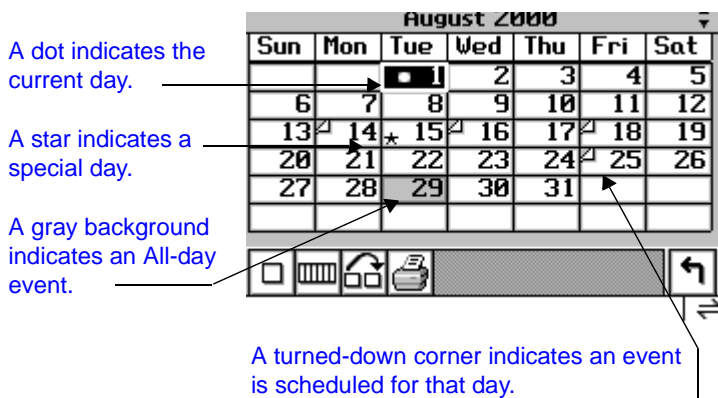

Adding an Event

You add new events from the Day View screen. If you are viewing your calendar using either the Week View or the Month View, you must first select Day View before adding a new calendar entry.

You can indicate that an event is recurring, and specify a schedule for how often it occurs and when it should stop repeating. By setting reminders and alerts, you can tell your Timeport P935 device to play an alert when you of a scheduled event.

To add an event:

1. Select the Calendar application from the Home screen.
2. From the Day View screen, select New Event.

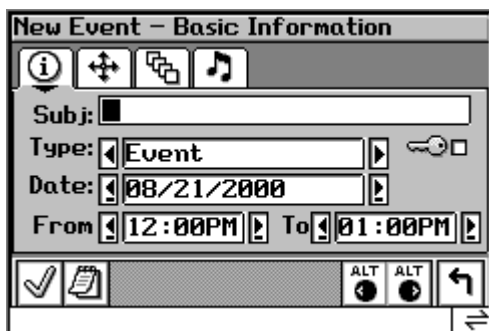

3. In the Subject field, type a brief description of this event.
4. Choose one of the following event types for this calendar entry:
 - Event
 - All-day event
 - Special day
5. If you want to make this event a private entry, select the Private check box.
6. In the Date field, type the date of the event.

TIP Press the NAVDISC left or right to increment or decrement the displayed date.

7. If this is an All-day appointment, choose the number of days. If this is an event, type the starting and ending time for the event. Calendar assumes that time entries between noon and 7 are p.m., and 8 through 11 are a.m.

TIP You can use the NAVDISC to increment or decrement the time by 15 minutes.

8. Select the Location tab.

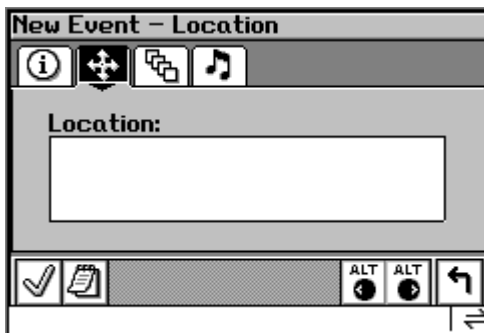

9. In the Location field, type the place for the event or leave this field blank.
10. Select the Repeat Options tab.

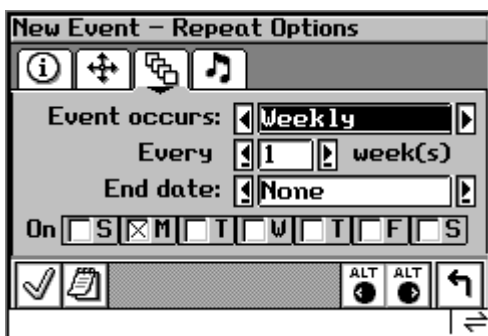

11. In the Event occurs field, choose a frequency for how often this event repeats.
12. If you selected an option other than Once in step 11, choose how often the event repeats.
13. In the End date field, type the date that this event will stop repeating.
14. If this is a weekly event that occurs some weekdays, but not all, select the On check boxes for the weekdays this event occurs.

If this is a monthly event, type the date of the month the event occurs.

15. Select the Alert Options tab.



16. In the Reminder field, type the time, prior to the event, that you want to receive a reminder alert.
17. In the Alert field, select the alert for this event reminder.

18. If you want the event reminder to sound even if the device is in silent mode, vibrate mode, or in Quiet Time, select the Play regardless of volume level option.
19. If you want to record additional information about this event, select the Notes for event button from the toolbar.
20. Type any additional information that you want to record about this event in Notes.
21. Select the Save note button from the toolbar to save your note.
22. Select the Save event button from the toolbar to save your entry.

Receiving Event Reminders

Prior to the start time for a scheduled event, you will receive an event reminder pop-up. Event reminders play based on the options you set when you created the event.

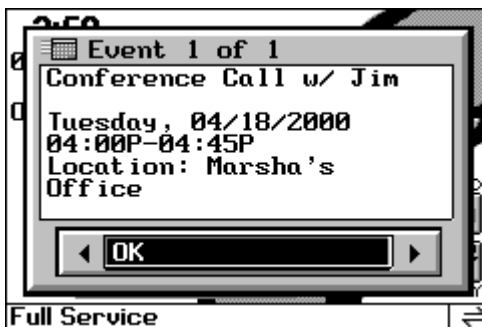

- When the event reminder pop-up appears, choose one of the following options:

OK	Closes the currently displayed event reminder pop-up.
Remind me in...	Redisplays the event reminder pop-up based on the time lapse you specify.
Exit	Closes all event reminder pop-ups.

Editing an Event

Calendar entries can be updated as information about your scheduled events changes.

To edit an event:

1. Select the Calendar application from the Home screen.
2. Select the Jump to date button from the toolbar.
3. In the Jump to field, type the date of the event or press the NAVDISC right to increment the field.
4. Select the OK button from the toolbar.
5. If you are in Day View, skip to the next step. Otherwise, highlight the day or date of the event and select Day View.
6. Highlight the event that you want to edit.
7. Select the View event button from the toolbar.
8. Select the Edit event button from the toolbar.
9. Modify the event information as desired.
10. Select the Save event button from the toolbar to save your modifications and return to the calendar view.

Deleting Events

You can delete events in Calendar in either of the following ways:

- Delete a calendar entry from the Day View screen.
- Delete a calendar entry after opening and reviewing it in the Event View screen.

To delete a calendar entry:

1. Select the Calendar application from the Home screen.
2. Select the Jump to date button from the toolbar.

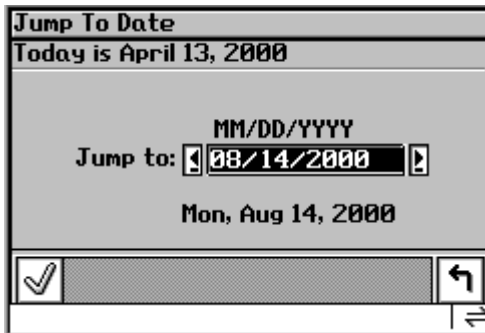

3. In the Jump to field, type the date of the event or press the NAVDISC right to increment the field.
4. Select the OK button from the toolbar.
5. If you are in Day View, skip to the next step. Otherwise, highlight the day or date of the event and select the Day view button from the toolbar.
6. Highlight the event that you want to delete.
7. Select the Put in trash button from the toolbar.

To review and then delete an event:

1. Select the Calendar application from the Home screen.
2. Select the Jump to date button from the toolbar.
3. In the Jump to field, type the date of the event or press the NAVDISC right to increment the field.
4. Select the OK button from the toolbar.
5. If you are in Day View, skip to the next step. Otherwise, highlight the day or date of the event and select Day View.
6. Highlight the event that you want to delete.
7. Select the View event button from the toolbar.
8. Review the event and then select the Put in trash button from the toolbar. The Day View reappears without the event.

Setting Calendar Preferences

Using Settings for Calendar you can select which calendar view you want to display as the default when you launch Calendar, as well as when events are removed from Calendar, when you want to receive reminders about events, and whether you want the alert to sound until read.

To set Calendar view preferences:

1. Select the Calendar application from the Home screen.
2. Select the Settings for Calendar button from the toolbar.

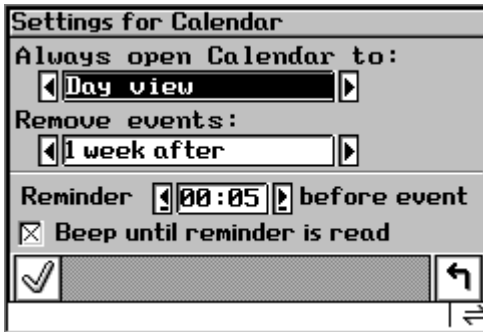

3. In the Always open Calendar to field, choose a default view for Calendar.
4. In the Remove events field, choose one of the following options for removing events from Calendar:
 - Immediately after the event occurs
 - One week after the event occurs
 - Thirty days after the event
 - Ninety days after the event
5. In the Reminder field, select the time in hours and minutes prior to the event that you want to receive an alert.
6. If you want event reminders to continue to play until read, select the Beep until reminder is read option.
7. Select the Save settings button to save your settings and return to a Calendar view.

Using Common Timeport P935 Features with Calendar

Calendar enables you to use a number of common features, including the following:

- Cut, copy, and paste event information to or from another event or another Timeport P935 PIM application.
- Insert text from another event or another Timeport P935 PIM application.
- Beam calendar events to other hand-held devices or printers that support IR communications.
- Restore deleted events from the Trashcan, if the Trashcan has not been emptied since the item was put in trash.

For more information about using these common Timeport P935 features, see Chapter 2, "Using Common Features."



Tasks provides you with the ability to create, store, and manage your “to do” items.

Using Tasks, you can:

- Make a quick list of things you don't want to forget.
- Assign due dates and priorities to your tasks.
- Mark tasks as completed.
- Organize your tasks into categories so that you can quickly locate tasks based on category.
- Sort tasks by priority or due date.

Prioritizing Tasks

You can assign any one of three priorities to your tasks:

-  High
-  Normal
-  Low

The priority, together with the due date, determines how tasks are listed on the main Tasks screen.

- If sorting by priority, all high priority tasks appear at the top of the screen followed by normal priority tasks, low priority tasks, and then completed tasks. Within each priority category, tasks are sorted by due date from sooner to later.
- If sorting by due date, past-due tasks appear at the top, followed by tasks that are due today, and finally all other tasks in due-date order. If multiple tasks are due on the same date, the tasks appear in high, normal, low, and completed priority by due date.

Creating a Task

Enter tasks to track things you need to do. You can organize your task list by assigning priorities and due dates to your tasks and classifying them by category.

To create a new task:

1. Select the Tasks application from the Home screen.

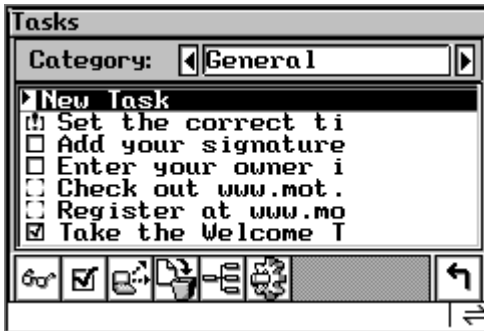

2. Select New Task.

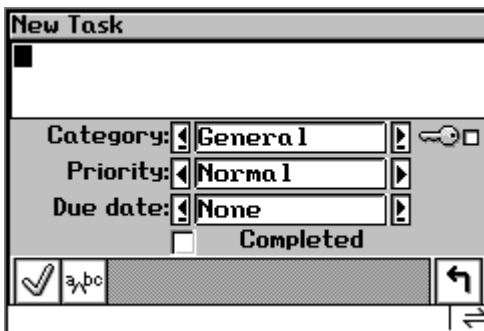

3. Type the task information in the New Task area.
4. In the Category field, choose a category for the task.

TIP You can also create a new category for a task. See "Using Categories" on page 33 for more information.

5. To make this a private task, select the Private check box.
6. Choose a priority for the task.
7. To assign a due date to the task, type the date in the Due date field.

TIP To remove a due date from a task, type **none** in the Due date field. The due date will change back to None.

8. If the task is already complete, select the Completed option.
9. Select the Save task button from the toolbar to save the task and return to the main Tasks screen.

Editing a Task

Tasks can be updated as information changes. Use this procedure to edit a task.

To edit a task:

1. Select the Tasks application from the Home screen.
2. From the Category field, choose the category of the task that you want to edit.
3. Using the NAVDISC, scroll through the list of tasks and highlight the task that you want to edit.
4. Select the View task button from the toolbar.

New Task
Make travel plans for week of 8/18

Category: Business

Priority: Normal

Due date: None

Completed

Save task

5. Select the Edit task button from the toolbar.
6. Modify the task. You can also change the category of a task during editing.
7. When you are finished, select the Save task button from the toolbar to save your changes and return to the main Tasks screen.

Viewing a Task

You can quickly view the tasks that you have created from the main Tasks screen. The screen displays the tasks by category. As you change the category, the list box updates to display only the tasks for that category.

To view a task:

1. Select the Tasks application from the Home screen.
2. From the Category field, choose the category of the task that you want to display. If you want to see all of the tasks that you have entered, change the category to All.

TIP When you start Tasks, the displayed category defaults to the category that was displayed when you last exited Tasks.

3. Using the NAVDISC, scroll through the list of tasks and highlight the task that you want to view.
4. Select the View task button from the toolbar.

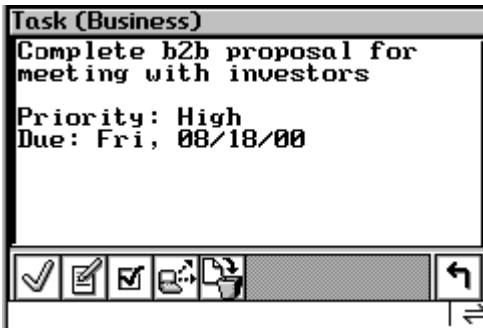

5. When you are finished viewing the task, select the OK button from the toolbar to return to the main Tasks screen.

Marking a Task as Completed

After you have completed a task, you can mark the task as completed. Completed tasks are displayed on the main Tasks screen after low priority tasks.

To mark a task as completed:

1. Select the Tasks application from the Home screen.

2. From the Category field, choose the category of the task that you want to display. If you want to see all of the tasks that you have entered, change the category to All.

TIP *When you start Tasks, the displayed category defaults to the category that was displayed when you last exited Tasks.*

3. Using the NAVDISC, scroll through the list of tasks and highlight the task that you want to mark as completed.
4. Select the Check as completed button from the toolbar. A check mark indicates that this task is completed.

TIP *If a highlighted task already has a completed task icon beside it and you select the Check as completed button from the toolbar, the status icon changes back to the original priority status.*

Deleting Tasks

You can delete tasks from your Timeport P935 device in any of the following ways.

- Delete a task directly from the main Tasks screen.
- Delete a task after opening and reviewing it in the View Tasks screen.
- Delete a task category and all of its corresponding task entries.

To delete tasks from the main Tasks screen:

1. Select the Tasks application from the Home screen.
2. From the Category field, choose the category of the task that you want to display. If you want to see all of the tasks that you have entered, change the category to All.
3. Using the NAVDISC, scroll through the list of tasks and highlight the task that you want to delete.
4. Select the Put in trash button from the toolbar.
5. The main Tasks screen reappears without the task.

To review and then delete a task:

1. Select the Tasks application from the Home screen.
2. From the Category field, choose the category of the task that you want to display. If you want to see all of the tasks that you have entered, change the category to All.
3. Using the NAVDISC, scroll through the list of tasks and highlight the task that you want to delete.
4. Select the View tasks button from the toolbar.
5. Review the task and then select the Put in trash button from the toolbar. The main Tasks screen reappears without the task.

To delete a task category and all of its tasks:

1. Select the Tasks application from the Home screen.
2. Select the Categories button from the toolbar.

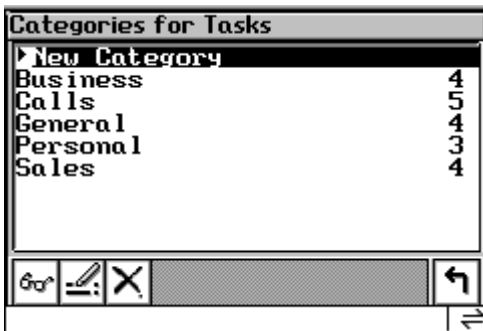

3. Using the NAVDISC, scroll through the list of categories and highlight the category that you want to delete. You cannot delete the General or Calls categories.
4. Select the Put in trash button from the toolbar. When the confirmation message box appears select Put in Trash.

Sorting Tasks

Task Settings enables you to determine whether you want to display tasks by priority or by due date.

To specify task settings:

1. Select the Tasks application from the Home screen.
2. Select the Settings for Tasks button from the toolbar.

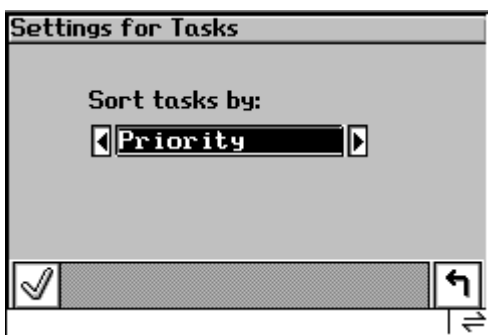

3. Choose whether to display tasks by priority or by due date.
4. Select the Save settings button from the toolbar to return to the main Tasks screen.

Using Common Timeport P935 Features with Tasks

Tasks enables you to use a number of common features, including the following:

- Define new categories for organizing your tasks into logical groups.
- Cut, copy, and paste task information to or from another task or other Timeport P935 PIM application.
- Insert text from another task or another Timeport P935 PIM application.
- Beam tasks to another hand-held device or printer that supports IR communications.
- Restore deleted tasks from the Trashcan, if the Trashcan has not been emptied since the item was put in trash.

For more information about using these common features, see Chapter 2, "Using Common Features."

Memos lets you easily compose and store notes that you want to have ready at hand.

Using the Memos application, you can:

- Quickly take notes or record other types of information on your Timeport P935 device.
- Organize your memos into categories so that you can quickly locate business-related memos, personal memos, or any other category you define.
- Send a memo to other Timeport P935 device users.

Viewing a Memo

The main screen displays the memos in the current category. As you change the category, the list box updates to display only the memos for that category.

To view a memo:

1. Select the Memos application from the Home screen.



2. From the Category field, choose the category of the memo that you want to display. If you want to see all of the memos that you have recorded, change the category to All.

TIP When you start Memos, the category defaults to the category that was displayed when you last exited Memos.

3. Using the NAVDISC, scroll through the list of memos and highlight the memo that you want to view.
4. Select the View memo button from the toolbar.

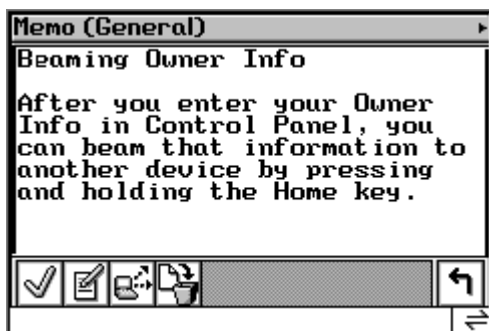

5. When you are finished viewing the memo, select the OK button from the toolbar to display the main Memos screen.

Composing and Editing Memos

You create and edit memo entries in much the same way. The Edit Memo screen lets you compose or edit a memo, and assign it to a category. You can also include a subject for a memo if you choose.

To compose a new memo:

1. Select the Memos application from the Home screen.
2. Select New Memo.

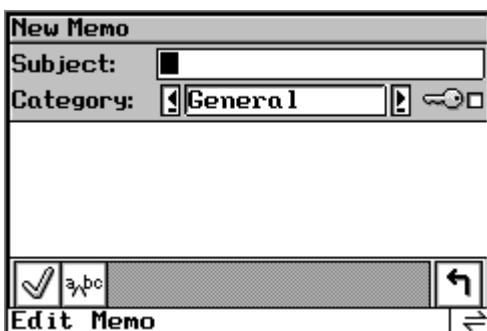

3. If you want to include a subject for the memo, type the subject text in the Subject field.

TIP Memos are sorted alphabetically by subject. Memos that do not contain a subject are sorted alphabetically by memo text.

4. In the Category field, choose a category for the memo.

TIP You can also create a new category for a memo. See "Using Categories" on page 33 for more information.

5. To make this a private memo, select the Private check box.
6. Type the text that you want to appear in the memo.
7. Select the Save memo button from the toolbar to save the memo.

To edit a memo:

1. Select the Memos application from the Home screen.
2. From the Category field, choose the category of the memo that you want to edit.
3. Using the NAVDISC, scroll through the list of memos and highlight the memo that you want to edit.
4. Select the View memo button from the toolbar.
5. Select the Edit memo button from the toolbar.
6. Edit the memo. You can also change the category of a memo during editing.
7. When you are finished, select the Save memo button from the toolbar to keep your changes.

Deleting Memos

You can delete memos from your Timeport P935 device in any of the following ways:

- Delete a memo directly from the main Memos screen.
- Delete a memo entry after opening and reviewing it in the View Memos screen.
- Delete a memo category and all of its corresponding memo entries.

To delete memos from the main Memos screen:

1. Select the Memos application from the Home screen.
2. From the Category field, choose the category of the memo that you want to display. If you want to see all of the memos that you have recorded, change the category to All.
3. Using the NAVDISC, scroll through the list of memos and highlight the memo that you want to delete.
4. Select the Put in trash button from the toolbar. The main Memos screen reappears without the memo.

To review and then delete a memo:

1. Select the Memos application from the Home screen.
2. From the Category field, choose the category of the memo that you want to display. If you want to see all of the memos that you have recorded, change the category to All.
3. Using the NAVDISC, scroll through the list of memos and highlight the memo that you want to delete.
4. Select the View memo button from the toolbar.
5. Review the memo and then select the Put in trash button from the toolbar. The main Memos screen reappears without the memo.

To delete a memo category and all of its memos:

1. Select the Memos application from the Home screen.
2. Select the Categories button from the toolbar.

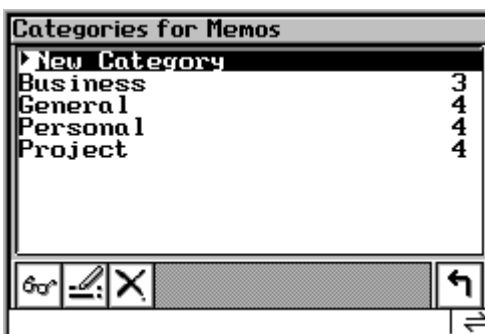

3. Using the NAVDISC, scroll through the list of categories and highlight the category that you want to delete.
4. Select the Delete category button from the toolbar and select Put in trash when the confirmation message box appears.

Using Common Timeport P935 Features with Memos

Memos enables you to use a number of common features, including the following:

- Define new categories for organizing your memos into logical groups.
- Cut, copy, and paste memo information to or from another memo or another Timeport P935 PIM application.
- Insert text from another memo or another Timeport P935 PIM application.
- Beam memo information to another hand-held device or printer that supports IR communication.
- Restore deleted memos from the Trashcan, if the Trashcan has not been emptied since the item was put in trash.

For more information about using these common features, see Chapter 2, "Using Common Features."

Alarm Clock allows you to set, display, and manage up to three different alarms on your Timeport P935 device that remind you of important activities or tasks that you need to perform.

Using Alarm Clock, you can:

- Set repeating wake-up alarms that play on weekdays, but not weekends.
- Set daily alarms that remind you when to exercise, practice an instrument, or feed your pet.
- Set once-only alarms to remind you of appointments.
- Specify different alert sounds for each of your alarms so that you can easily distinguish among them.
- Toggle your alarms on and off so that they are active only when you need them. A bell icon next to the alarm indicates it is on.
- Use your Timeport P935 device as a travel alarm clock, complete with a snooze setting.

Viewing Your Alarms

Alarm Clock lets you set up to three different alarms.

A bell icon indicates that an alarm is turned on.

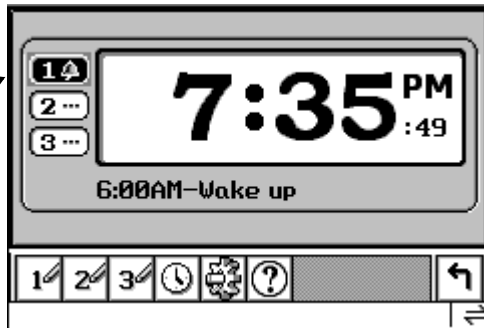

Setting Alarms

When you set new alarm clock entries, you name the alarm, specify the time of the alarm, set the frequency that it occurs, and specify which alert sound the alarm should play.

To set a new alarm clock entry:

1. Select the Alarm Clock application from the Home screen.
2. Select the Alarm 1, Alarm 2, or Alarm 3 button from the toolbar to create the alarm entry.

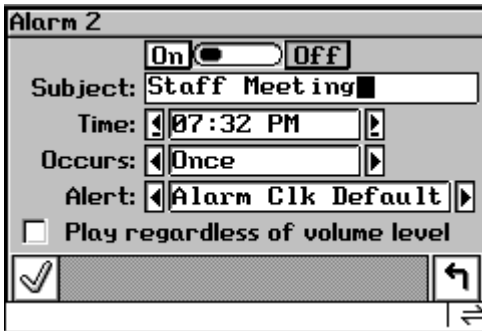

3. Toggle the alarm on or off by pressing the NAVDISC right or left.
4. In the Subject field, type the name of the new alarm.
5. In the Time field, either type the time for the alarm or use the NAVDISC to increment or decrement the default time, as appropriate.
6. In the Occurs field, choose a frequency for the alarm.
7. In the Alert field, choose the alert sound that you want the alarm to play.
8. If you want the alarm to sound even if the device is in silent mode, vibrate mode, or in Quiet Time, select the Play regardless of volume level option.
9. Select the OK button on the toolbar to save your new alarm entry.

To edit an alarm:

1. Select the Alarm Clock application from the Home screen.
2. Select the Alarm 1, Alarm 2, or Alarm 3 button from the toolbar, depending on which alarm entry you want to edit.

3. Modify the alert as desired.
4. When you are finished making changes, select the OK button from the toolbar.

Turning Alarms On and Off

Once you create an alarm, you can choose whether the alarm is on or off. This allows you to control the state of the alarm and determine whether it is played or not. For example, you may wish to turn off certain alarms while you are on vacation or out of town on business and turn them back on when your normal routine resumes.

To toggle an alarm on and off:

1. Select the Alarm Clock application from the Home screen.
2. Highlight the alarm icon whose state you want to toggle.
3. Press ENTER to toggle the alarm on and off. When the alarm is on, a bell appears next to the alarm number. Otherwise, an ellipsis appears next to the alarm.

Setting Alarm Clock Options

Using Alarm Clock Settings, you can specify certain default values for the Alarm Clock application.

To change alarm clock settings:

1. Select the Alarm Clock application from the Home screen.
2. Select the Settings for Alarm Clock button from the toolbar.

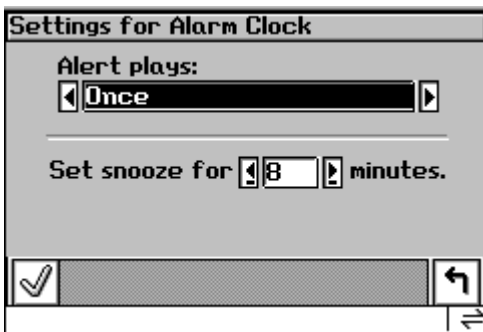

3. In the Alert plays field, choose how long you want alarms to play.

4. In the Set snooze for minutes field, select the number of minutes that you want Alarm Clock to wait before repeating an alarm.
5. Select the Save settings button from the toolbar.

About Alarm Sounding Mode

Turn your Timeport P935 communicator into a portable travel alarm clock by placing it in the docking station while you are using the Alarm Clock application.



When the alarm goes off, an alarm pop-up appears and the alarm sounds based on the Alarm Clock settings you specified.

To turn the alarm off:

1. Press the NAVDISC left or right to choose from the following options:
 - Turn off
 - Snooze
2. Press ENTER to perform the action.













Calculator is a desktop calculator application that enables you to perform basic arithmetical calculations.

Using Calculator, you can do the following:

- Perform basic addition, subtraction, multiplication, and division operations.
- Store and retrieve numbers from memory.
- Calculate tax and tip based on percentages you specify.
- Perform calculations using special formulas.
- Set preferences for how numbers should be displayed.

Calculator Buttons

Use the following table to determine what action the calculator buttons perform.

	Adds the next number you type to the current total		Calculates the reciprocal of the displayed number
	Subtracts the next number you type from the current total		Displays the result of multiplication as a percentage
	Multiplies the next number you type by the previous number		Changes the sign of the displayed number
	Divides the next number you type by the previous number		Performs any operation on the previous two numbers
	Clears the calculation		Clears the memory
	Clears the displayed number		Recalls (displays) the number stored in memory

Tax Calculates the tax on the amount currently displayed, based on the tax percentage you indicated in Calculator Settings





MS Stores a number in memory. If a number is already stored in memory, this clears the memory and then stores the new number.

Tip Calculates the tip for the current amount, based on the tip rate you enter in Calculator Settings

M+ Adds the displayed number to a number already stored in memory

Keyboard Shortcuts

If you'd rather use the keyboard keys on your device than select the buttons on the Calculator screen, use the following key equivalents.

Keyboard Key	Screen Button
p (plus) or ALT +	
m (minus) or hyphen	
d (divide) or /	
t (times) or x	
e (equal) or =	

Using Calculator

You can use Calculator to perform simple calculations, store values in memory that you want to reuse, or perform percent calculations. Calculator includes a tape area that displays your work.

To perform a simple calculation:

1. Select the Calculator application from the Home screen.

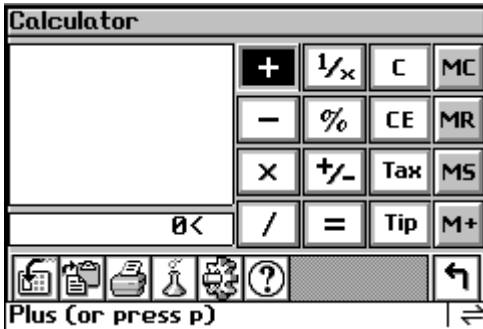

2. Type the first number in the calculation.
3. Select the operator button for the calculation: + to add, - to subtract, x to multiply, or / to divide.
4. Press the ENTER key, unless you used the keyboard shortcuts.
5. Type the next number in the calculation.
6. Type any remaining operators and numbers.
7. Select the = button.
8. Press the ENTER key.

About Formulas

Calculator includes several formulas that guide you through some typical calculations. These include the ability to determine:

- How to split a check, based on check amount and number of parties dividing the check
- A loan payment, based on loan amount, annual percentage rate, and term
- The purchase price of an item, based on its original cost, discount percentage, and sales tax

In addition, Calculator gives you the ability to manage the formulas that you use. For example, you can delete formulas that you do not use, or send formulas to other Timeport P935 device users.

To perform an operation using a pre-defined formula:

1. Select the Calculator application from the Home screen.
2. Select the Insert formula button from the toolbar.

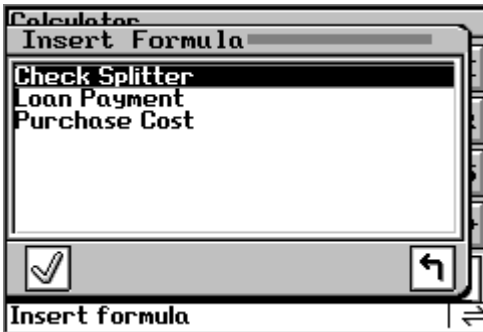

3. From the Formula list, choose the formula you want to use.
4. Select the OK button from the toolbar.

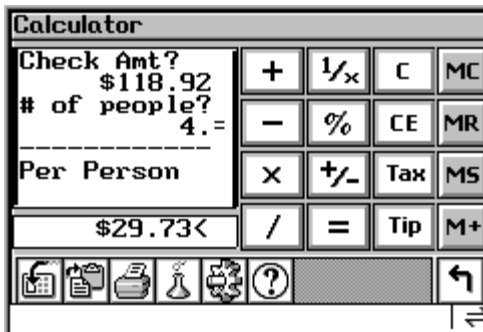

5. Respond to each of the prompts displayed in the tape area and press the ENTER key. When you are finished responding to the prompts, Calculator will perform the operation and display the results at the end of the tape.

To delete formulas:

1. Select the Calculator application from the Home screen.
2. Select the Formulas button from the toolbar.

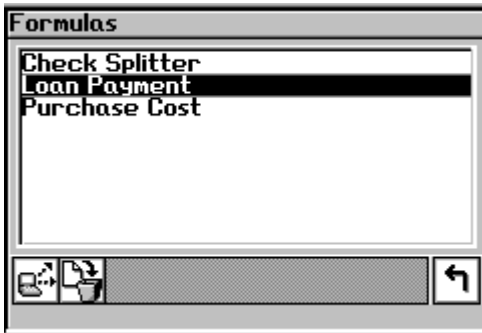

3. Select the formula that you want to delete.
4. Select the Put in trash button from the toolbar.

To send formulas to other Timeport P935 device users:

1. Select the Calculator application from the Home screen.
2. Select the Formulas button from the toolbar.
3. Select the formula that you want to send.
4. Select Send. See "Sending Information" on page 38 for additional information.

Setting Calculator Options

There are several options that enable you to customize how Calculator displays your work and to specify what percentage amounts to use when calculating tax and tip information.

To set Calculator preferences:

1. Select the Calculator application from the Home screen.
2. Select the Settings for Calculator button from the toolbar.

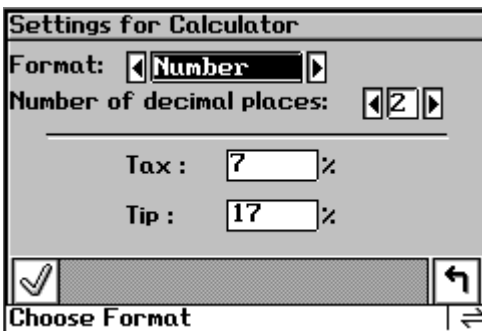

3. In the Format field, choose whether you want Calculator to display numbers as currency.
4. In the Number of decimal places field, type the number of decimal places to display when performing calculations.

TIP *Currency automatically displays two decimal places.*

5. In the Tax % field, type the percent you want Calculator to use when determining the tax on a particular amount.
6. In the Tip % field, type the percent you want Calculator to use when calculating a tip amount.
7. Select the Save settings button from the toolbar to save your preferences and return to the main Calculator screen.

Jukebox provides you with a selection of basic and system alerts that you can use to personalize your message notification alerts and event reminders. In addition, Jukebox gives you the ability to compose your own custom alerts.

Using Jukebox, you can:

- Modify, add, or compose custom musical themes or other special effects using the powerful alert script language composition language.
- Use different alerts for new message notification, event reminders, or to let you know when you've received a message from a specific sender.
- Activate standard and custom jukebox alerts for use in other Timeport P935 applications.
- Share your jukebox alerts with other Timeport P935 device users.

About Jukebox Alerts

Jukebox alerts consist of the following:



Basic alerts consist of both standard alerts provided by Motorola and custom alerts you compose.

Basic alerts can be turned on or off. When turned on, they are preceded by a double note.

You can edit, send, beam, or delete basic alerts.



Application alerts are associated with specific Timeport P935 applications, such as the Ship2Ship application.

You cannot edit application alerts; however, they can be sent, beamed, or deleted.



System alerts are built into certain Timeport P935 applications.

You cannot edit, send, beam, or delete system alerts.

Playing Jukebox Alerts

The Jukebox application provides basic and system alerts that you can use as message alerts or event reminders. You can sample jukebox alerts before assigning them as alerts or reminders.

To play a jukebox alert:

1. Select the Jukebox application from the Home screen.

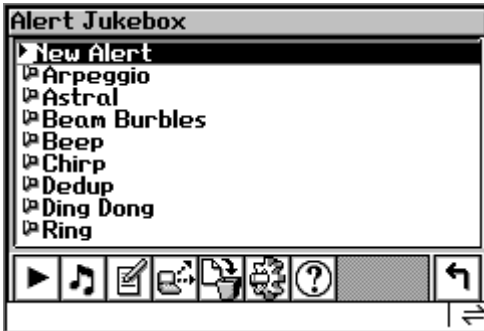

2. Highlight the basic alert, application alert, or system alert that you want to sample.
3. Select the Play alert button from the toolbar. After a few moments, the jukebox alert plays.

TIP You can play alerts in Jukebox without turning them on. However, to activate alerts so that they are available in other applications, you must turn them on.

Downloading Additional Jukebox Alerts

Jukebox comes with several alerts already installed. You can order additional free alerts to be sent to your Timeport P935 device by visiting our web site at the following location.

http://www.mot.com/MIMS/PSD/products/jukebox/alert_jukebox.html

Note You are responsible for the air time costs associated with receiving jukebox alerts.

Turning Jukebox Alerts On and Off

When you compose a new alert, or receive a custom alert from another Timeport P935 device, it is automatically installed in Jukebox with an alert status of OFF. To use the alert as an alert, you must first turn it ON in Jukebox.

To conserve memory, you should turn OFF unused alerts. Turning OFF an alert does not remove it from the device. The alert can be turned back on at any time.

To turn a jukebox alert on or off:

1. Select the Jukebox application from the Home screen.
2. Highlight the name of the alert.
3. Select the Turn on/off button from the toolbar to toggle the state of the alert. Alerts that are on are preceded by a double note.

Composing or Editing a Jukebox Alert

You can compose your own custom jukebox alerts to use as message alerts or event reminders.

To compose an alert:

1. Select the Jukebox application from the Home screen.
2. To compose a new alert, select New Alert.

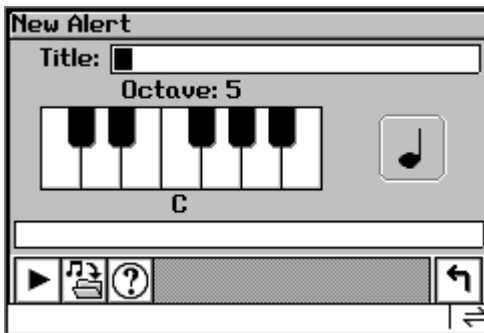

3. In the Title field, type the name of the alert.
4. Do one of the following:
 - Using the NAVDISC, select the notes, octave, and note lengths for your alert. Pressing the NAVDISC left and right selects the note; pressing the NAVDISC up and

down selects the note length. When the correct note, octave, and note length are displayed, press the SPACE key to hear the note or press the ENTER key to both hear the note and copy it to the notes text box below the piano keyboard.

- In the notes text box below the piano keyboard, type the alert script language symbols for your alert using the alert codes in alert script language.

TIP To see a reference list of alert script language alert codes, select the Help button from the toolbar. For detailed information on how to write alerts with alert script language, see "Using Alert Script Language" on page 117.

5. To sample your composed alert, select the Play alert button from the toolbar.
6. When you are finished composing your alert, select the Save alert button from the toolbar to save your custom alert.
7. Select the Exit screen button from the toolbar to exit the New Alert screen and return to the main Alerts screen. Your new custom alert should appear in the Alerts list.
8. To play the new alert, highlight the name of the alert and select the Play alert button from the toolbar.
9. To turn on your alert, highlight the name of the alert and select the Turn on/off button from the toolbar.

Deleting Jukebox Alerts

You can remove basic and application alerts at any time. If the alert was being used as a message alert or event reminder, the Ring system alert is used in its place.

Be careful about deleting application alerts that were installed with add-on applications. If you delete the associated alerts and then attempt to use the application, the application may not function correctly.

You cannot delete system alerts.

To delete a jukebox alert:

1. Select the Jukebox application from the Home screen.
2. Highlight the alert you want to remove.

3. Select the Put in trash button from the toolbar.
4. Select the Exit screen button from the toolbar to return to the Home screen.

Using Alert Script Language

alert script language is a scripting language that allows you to compose alerts on your device. With alert script language, you can compose any alert where one note is being sounded at any one time. Just as the human voice can't produce two notes at the same time, your device can only play one note at a time.

alert script language supports octaves, note values, rests, sharps, flats, and some special effects.

The Basics

To understand alert script language, think of a piano keyboard, as shown below:



These same notes, which make up the C scale starting at middle C, are represented in a written score as shown below:



In alert script language, each note is represented by the corresponding upper-case letter, as follows:

CDEFGABC

Formatting Your Alert Script Language Text

When you create an alert using alert script language, you can use spaces to improve the readability of the text. When your Time-

port P935 device plays an alert script language alert, it ignores all spaces.

Although the examples in this documentation use spaces to improve the readability, keep in mind that you don't have to use them when you create your own alerts.

Using Multiple Octaves

In alert script language, each octave is designated with a number from 1 to 8, for a total of eight octaves. The octave that starts with middle C has an octave number of 4. To use a note that is outside of the octave, you must type the new octave number before the letter. When the device plays the alert, it will continue playing in the same octave until it encounters a different octave number.

If you do not specify an octave number at the beginning of your alert, the device will use octave number 5 by default.

To play the C scale starting with middle C and ending with the C above middle C, type the following:



4CDEFGAB 5C





To play the C scale starting with middle C, and then play the descending scale, type the following:

4CDEFGAB 5C 4BAGFEDC

Assigning Note Values

In music, notes have values that define how long the note should be sounded. The following table describes the note values supported by alert script language. When the device plays an alert, the notes are held for the length of time shown in the alert script language time value column.

Note	Name	Relative length	Alert script language symbol	Alert script language time value
	Whole note	4 beats	w	2 seconds
	Half note	2 beats	h	1 second

	Quarter note	1 beat	q	1/2 second
	Eighth note	1/2 beat	e	1/4 second
	Sixteenth note	1/4 beat	s	1/8 second
	Thirty-second note	1/8 beat	t	1/16 second
	Dot	Increase the length of note 50 percent	.	Increase the time value 50 percent

To assign a value to a note, type the note value symbol after the letter for the note. When the device plays the alert, it will continue giving each note this new value until it encounters a different note value symbol.

The following figure shows the first two measures of Silent Night.









To play this alert using alert script language, type the following:

Gq. Ae Gq Eh.

Using Rests

Rests are periods of time in which no note is sounded. Rests have the same values as notes, as shown in the following table.

Rest	Name	Relative length	Alert script language symbol	Alert script language time value
	Whole rest	4 beats	Rw	2 seconds
	Half rest	2 beats	Rh	1 second
	Quarter rest	1 beat	Rq	1/2 second
	Eighth rest	1/2 beat	Re	1/4 second
	Sixteenth rest	1/4 beat	Rs	1/8 second
	Thirty-second rest	1/8 beat	Rt	1/16 second
	Dot	Increase the length of rest 50 percent	.	Increase the time value of rest 50 percent

To add a rest, type an upper-case R followed by the alert script language time value symbol.

The following figure shows the first two measures of *Silent Night*, but the last dotted half note is changed to a half note with a quarter rest.



To play this alert using alert script language, type the following:

Gq. Ae Gq Eh Rq

Maximum Alert Lengths

Alerts written with alert script language cannot exceed 30 seconds. If you create an alert longer than 30 seconds and then try to play it, your device will not sound any notes.

To calculate an alert length, use the tables in the "Assigning Note Values" and "Using Rests" sections to sum up the time values for all notes and rests in your alert.

Adding Sharps, Flats, Naturals, and Accidentals

If an alert is written in any key other than C major and A minor, a key signature appears, defining which notes must be sharped (raised $\frac{1}{2}$ step) or flatted (lowered $\frac{1}{2}$ step) throughout the entire piece of music. A natural is a note that the key signature indicates should be sharped or flatted, but that should not be altered for that particular note.

An accidental is a note that should be sharped or flatted for a single note only. (In music, an accidental affects all occurrences of the same note within a measure. On the device, an accidental affects only one note.)

The following table describes how these elements are supported by alert script language.

Symbol	Name	Alert script language symbol	Example
#	Key signature sharp	S before the note letter at the beginning of the alert. This note is not sounded by the device.	SF SFSC
b	Key signature flat	f before the note letter at the beginning of the alert. This note is not sounded by the device.	fB fBfE
n	Natural	n after the note letter	Fn
#	Accidental sharp	# after the note letter	F#
b	Accidental flat	b after the note letter	Bb

If an alert changes key, the key signature also changes to indicate which notes (if any) are sharped or flatted for the new key. If you want to change keys with alert script language, you must enter new symbols to indicate which notes should be sharped or flatted. To indicate that a note should no longer be sharped or flatted, type an upper-case N followed by the letter. This note is not sounded by the device.

The following figure shows an F-sharp in the key signature. There are accidental flats on the D and the A. The second F is a natural. The last note is also an A-flat because, in written music, an accidental affects all occurrences of the same note within a measure.



To play this alert using alert script language, type the following:

SF

Fq Db Ab Fn Ab

In this example, the first line, which acts like a key signature, instructs the device to sharp all F's. The D-flat and A-flats are accidentals, which means no other A's or D's will be flatted unless they also have a flat symbol after the note letter. The F-natural affects this F only; the device will sharp the next F it encounters because of the "key signature" in the first line.

Tempo

Tempo refers to the rate of speed that individual notes in an alert are played. In Jukebox, the default tempo is 120 quarter notes per minute. You can increase or decrease the tempo as appropriate for your alert.

Staccato and Legato

Staccato means that a note should have a slight break after it and before the next note is sounded. Legato means that the notes should be blended together. By default, the device plays all notes staccato.

To blend a series of notes together, place a lower-case k after a note to start the blending, and place an upper-case K after a note to stop the blending.

The following figure shows the first measure of *Three Blind Mice*.



To play the notes first as staccato (with a slight break), and then legato (blended), type the following:

E D C E k D C K

Volume

alert script language allows you to assign nine levels of volume to notes, as shown in the following table. By default, the device plays notes at a volume level of 9.

Symbol	Description
a1 - a9	Volume level from lowest to highest
+	Increases volume one level (up to level 9)
-	Decreases volume one level

To change the volume of an alert, place the volume symbol before the note for which you want to change the volume. You can use multiple + and - symbols to increase and decrease the volume multiple levels.

Note *The volume level you set on the Home screen affects all alerts that do not include volume control symbols. If you have included volume control symbols in your alert, the device will play them at that volume level, regardless of the volume level selected on the Home screen.*

To play the entire C scale increasing the volume on each ascending note, and decreasing the volume on each descending note, type the following:

a1 C +D +E +F +G +A +B +6C +C -5B -A -G -F -E -D -C -C

In this example, the volume starts at level one, which is the softest level. The volume increases for each note until level 9 is reached on the second C in octave number 6. The volume then decreases for each note until level 1 is reached on the final C.

The following figure shows the first two measures of *Silent Night*, showing a crescendo and decrescendo. The crescendo (<) means to increase volume, and the decrescendo (>) means to decrease volume.



To play this alert using alert script language, type the following:

a2Gq. ++Ae -Gq -Eh.

In this example, the two ++ symbols would increase the volume for the A by two levels.

Special Effects

alert script language allows you to add two special effects to your alerts: the red LED indicator on the front of the device and the vibrating feature. The following table describes how to turn these features off and on.

Symbol	Description
Lr	Turn red LED on
lr	Turn red LED off
V	Turns vibrator on
v	Turns vibrator off

In the following example, the vibrator and LED special effects were added to *The Blue Danube*.

CCEGGh

V Lr Ge Ir v

Re

V Lr Gh Ir v

V Lr Ee Ir v

Re

V Lr Eh Ir v

In this example, the second, fourth, fifth, and seventh lines turn the vibrator on, turn the LED on, play the note, turn the LED off, and turn the vibrator off.

Sample Alert Script Language Alerts

The following sample alerts are provided to give you practice using the alert script language composition language.

The Blue Danube

4C C E G Gh

V Lr Ge Ir v Re V Lr Gq Ir v Rq

V Lr Ee Ir v Re V Lr Eq Ir v Rq

Cq C E G Gh

V Lr Ge Ir v Re V Lr Gq Ir v Rq

V Lr Fe Ir v Re V Lr Fq Ir v Rq

DqDFAAwF#qG5Ew

Cq 4E Eh Dq Ah Gq C Ce Ce Cq

V Lr Cq Ir v

The Entertainer

Ds E C4 Ae Bs G Rs 5Ds E C4 Ae Bs G Rs
4Ds E C3 Ae Bs A Ab Ge Re 5Gs Rs 4Ds D#
Lr E 5lr Ce 4Es
Lr 5Ce 4Es lr 5Cq.
Lr Cs D D# lr E C D Ee
Lr 4Bs 5De Cq lr Rs5 Cs D D# E C D Ee
Lr Cs lr DC
Lr E lr Cs D Ee Cs D C E C D Ee 4Bs 5D Rs C

Reveille

Lr Ds. G Bt. G lr Ds. B G Bt. G
Lr Ds. B G Bt. G lr Ds. Gs. Be. Gs.
Lr D G Bt. G lr Ds. B G Bt. G
Lr Ds. B G Bt. G lr Ds. D Lr Ge Re
Lr Bs. B B B Bt. lr B 6De.
5Lr Bs. G B G lr B Gt. G Be. Gs.
Lr Bs B B B B lr 6De.
5Lr Bs. Gt. B6 Ds. lr 5Bt. G Ds. Lr D G lr

Stars and Stripes Forever

SF
De Lr D Ct. 4B Be lr Bbt. B
Lr Bq Bbt. lr B Be lr Bbt. lr B
Lr 5C lr 4B A F Ae..
Lr Ge G G Ft. lr G Bbe At.
Lr G5 Gq lr Rt.
Lr 4Gt.. A lr B 5D
4Lr G A B lr 5D
4Lr D E B lr Ae.
Lr Gs lr

When the Saints Go Marching In

Lr 4Cs Ir E Fs Lr Gq Ir

Lr Cs Ir E F Lr Gq Ir

Lr Cs Ir E F Lr Ge Ir E Lr C Ir E Lr Dq Ir

Es E D Lr Ce. Ir Cs Ee Gs G Lr Gs Fq Ir

Lr Ct. Ir Es Lr F Ge Ir E Lr C Ir D Lr C

Alert Script Language Quick Reference

Use the following list of alert script language symbols when composing alerts.

Symbol	Description	Example
.	Increases a note duration or rest by 50 percent.	Fq.
+	Increases volume one level (up to level 9).	+F
-	Decreases volume one level.	-F
#	Sharps the preceding note.	F#
1-9	Specifies the octave for the note. The default octave is 5. The middle C octave is 4.	4C
ax	Indicates the volume level. a0 is silent, and a9 is the highest volume.	a6
b	Flats the preceding note.	Bb
e	Represents an eighth note.	Ce
f	Specifies that all occurrences of a certain note should be flatted in the entire alert.	fB
h	Represents a half note.	Ch
k	Starts a legato (blending) effect. Used with K.	CkEGK
lr	Turns the red LED off. Used with LR.	LrGlr
n	Specifies that the preceding note should not be sharped or flatted, although the key signature indicates it should be.	Fn
q	Represents a quarter note.	Cq
s	Represents a sixteenth note.	Cs
t	Represents a thirty-second note.	Ct

v	Turns the vibrator off. Used with V.	VGv
w	Represent a whole note.	Cw
A - G	Represents the corresponding note.	A
K	Staccato (default). Stops a legato (blending) effect. Used with k.	CkEGK
Lr	Turns the red LED on. Used with lr.	LrGlr
N	Changes a note from being sharped or flatted for the remainder of the alert.	NB
R	Represents a rest and is followed by the value for the rest.	Rq
S	Specifies that all occurrences of a certain note should be sharped in the entire alert.	SF
Tnnn%	Specifies the tempo for the alert. The default is 120 quarter notes per minute.	T100%
V	Turns the vibrator on. Used with v.	VGv

The Control Panel application provides a variety of features that enable you to customize your Timeport P935 device to suit your individual needs

Using Control Panel, you can do the following:

- View version, operating system, and memory allocation information.
- Free up memory using a cleanup utility or by deleting unused add-on applications.
- Enable, disable, or temporarily suspend visual and audio alerts.
- Specify desktop synchronization, Internet fax gateway service, and IR-enabled printer settings.

Note *The Timeport P935 device is designed to synchronize with basic features of the initial release of many popular Personal Information Management (PIM) software and hardware products.*

The Internet fax gateway service is a network and subscription dependent feature and may not be available in all areas.

- Customize the user interface to reflect your personal preferences.
- Create and maintain text entry shortcuts that make composing and replying to messages even faster and easier.
- Create an electronic business card, or vCard, that enables you to automatically exchange your personal contact information with other hand-held organizers.
- Secure the information on your messaging device using privacy options.

About Control Panel

You can customize your Timeport P935 messaging device to suit your individual needs using Control Panel. Control Panel provides access to the following applications:

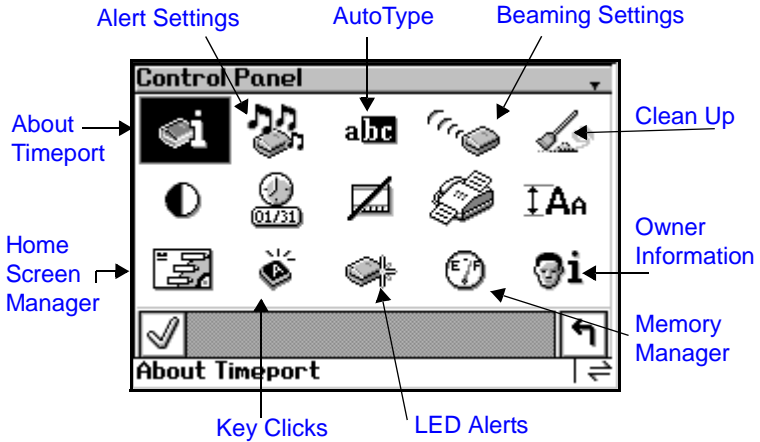

Press the NAVDISC down to see all of the application icons on the Control Panel. To select applications in Control Panel, press the TAB key to highlight the application, then press ENTER to open the application.

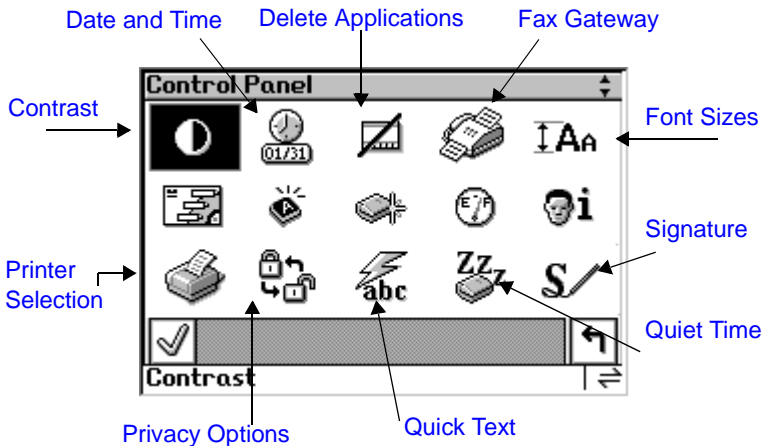

Managing System Information

Control Panel provides access to the following types of information:

- System information
- Memory usage information

In addition, you can delete add-on applications that you no longer use in order to increase the free memory on your Timeport P935 device.



Viewing About Timeport Information

The About Timeport feature enables you to view version, model, operating system, and copyright information

To view system information:

1. Select the Control Panel application from the Home screen.
2. Select the About Timeport icon from the Control Panel.

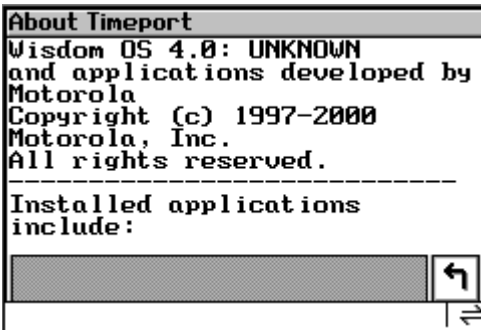

3. Press the NAVDISC down to review a list of installed applications.
4. When you are finished reviewing system information, select the Exit screen button from the toolbar to return to Control Panel.



Working with Memory Manager

The Memory Manager feature enables you to view the amount of used and available memory on your messaging device. Further, you can view how much memory is allocated to each application and application data. You can also delete certain applications from within Memory Manager.

Note The memory usage level refers to persistent flash storage (analogous to the hard drive on your PC) rather than volatile memory (RAM).

To view memory usage:

1. Select the Control Panel application from the Home screen.
2. Select the Memory Manager icon from the Control Panel to view the percentage of used and available memory on the device.

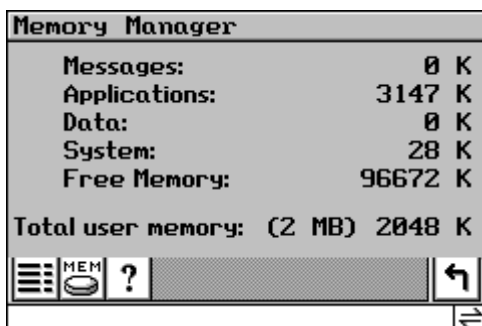

The screenshot shows the Memory Manager application window. It displays the following memory usage statistics:

Category	Value
Messages:	0 K
Applications:	3147 K
Data:	0 K
System:	28 K
Free Memory:	96672 K
Total user memory:	(2 MB) 2048 K

At the bottom of the window, there is a toolbar with icons for a list, a memory icon labeled 'MEM', a question mark, and a back arrow.

3. Select the Details button on the toolbar to view the amount of memory used by each application and by application data.

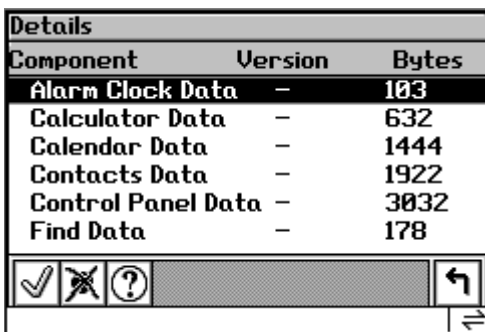

The screenshot shows the Details application window, which provides a breakdown of memory usage by component:

Component	Version	Bytes
Alarm Clock Data	-	103
Calculator Data	-	632
Calendar Data	-	1444
Contacts Data	-	1922
Control Panel Data	-	3032
Find Data	-	178

At the bottom of the window, there is a toolbar with icons for a checkmark, a cross, a question mark, and a back arrow.

4. Select the OK button from the toolbar.
5. Select the Total memory button from the toolbar to view the amount of usable memory, reserved memory, and random access memory (RAM) allocated on the device.

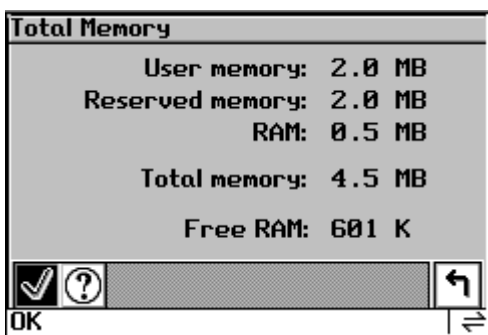

6. When you are finished viewing memory information, select the OK button on the toolbar to return to Control Panel.

To delete applications from the Memory Usage screen:

1. From the Details screen, highlight the application that you want to delete. Applications that are eligible for deletion are preceded by a dot.
2. Select the Delete application button on the toolbar.
3. When the confirmation pop-up appears, select OK.
4. Select the OK button on the toolbar to return to the Memory Manager screen.
5. Select the Exit screen button on the toolbar to return to the Control Panel.



Deleting Add-On Applications

The Delete Applications feature enables you to remove unwanted applications from your Timeport P935 device.

To delete applications from Timeport P935:

1. Select the Control Panel application from the Home screen.
2. Select the Delete Applications icon from Control Panel.

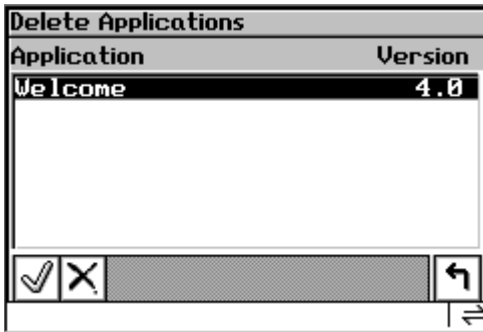

3. Highlight the application that you want to delete.
4. Select the Delete application button on the toolbar.
5. When the confirmation pop-up appears, select OK.
6. Select the OK button on the toolbar to return to Control Panel.



Running the Clean Up Utility

If you are running low on memory, you can free up space on your device by running the clean-up utility.

To run the clean-up utility:

1. Select the Control Panel application from the Home screen.
2. Select the Clean Up icon from Control Panel.

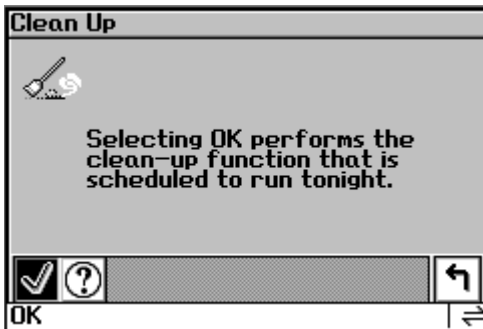

3. Select the OK button from the toolbar.

Enabling and Disabling Alerts

The Timeport P935 device allows you to enable, disable, or temporarily suspend audio and visual alerts using the following features:

- Alert Settings
- LED Alerts
- Quiet Time



Using Alert Settings

The Alert Settings feature enables you to select the default alert that you want to use for each application that plays alerts.

To enable/disable alert settings:

1. Select the Control Panel application from the Home screen.
2. Select the Alert Settings icon from the Control Panel.

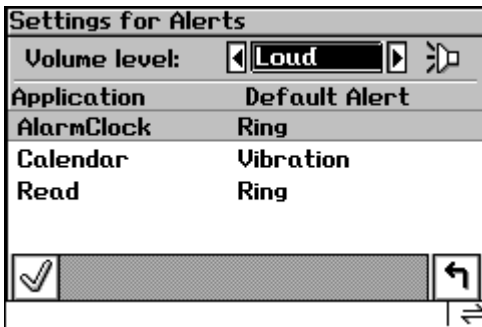

3. In the Volume level field, specify the default volume level for your device.
4. Highlight the application for which you want to specify a default alert.
5. Press the NAVDISC left or right to choose the alert you want to play.
6. Select the Save settings button on the toolbar to set the default alerts.



Using LED Alerts

The LED Alerts feature allows you to enable or disable LED alerts.

To enable/disable LED alerts:

1. Select the Control Panel application from the Home screen.
2. Select the LED Alerts icon from the Control Panel.

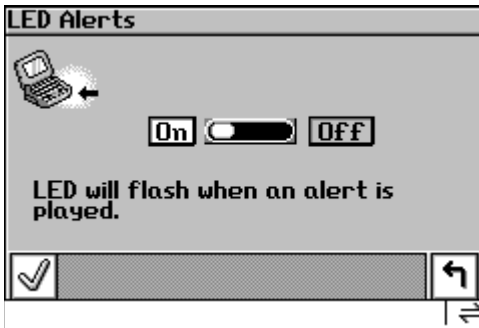

3. Toggle the LED alert on or off by pressing the NAVDISC left or right.
4. Select the Save settings button on the toolbar when you are finished.



Using Quiet Time

The Quiet Time feature lets you specify daily time periods during which message alerts and Alarm Clock alarms will not be played, unless you choose to override Quiet Time settings. During Quiet Time, the volume level is set to Silent.

To enable/disable Quiet Time settings:

1. Select the Control Panel application from the Home screen.
2. Select the Quiet Time icon from the Control Panel.

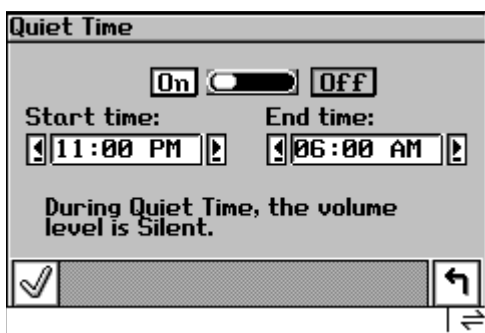

3. Toggle the Quiet Time settings on or off by pressing the NAV-DISC left or right.
4. In the Start time and End time fields, type the beginning time and ending time for the Quiet Time period.
5. Select the Save settings button on the toolbar to return to the Control Panel.

Managing Desktop, Fax, Print, and Beam Settings

You can control the way your Timeport P935 device interacts with external devices, such as your PC, Fax gateway service, printer, or other Timeport P935 devices using the following features:

- Synchronization Settings
- Internet Fax Service
- Printer Settings
- Beaming Settings



Maintaining Synchronization Settings

The Timeport P935 device is designed to synchronize with basic features of the initial release of many popular Personal Information Management (PIM) software and hardware products. If you installed the Desktop applications that shipped with the Timeport P935 CD, make certain that you review Synchronizing Settings in Control Panel. The TrueSync® software applications enable you to synchronize PIM information on your Timeport P935 device with your PC desktop applications.

Using Synchronizing Settings, you can require that a password be entered on your messaging device before synchronization begins. This helps prevent the desktop from synchronizing with your device without your intervention.

To set synchronization settings:

1. Select the Control Panel application from the Home screen.
2. Select the Synchronizing Settings icon from Control Panel.



3. To require password entry on the device prior to synchronization, select the Prompt for password when desktop tries to sync option.
4. Select the Change password button from the toolbar.

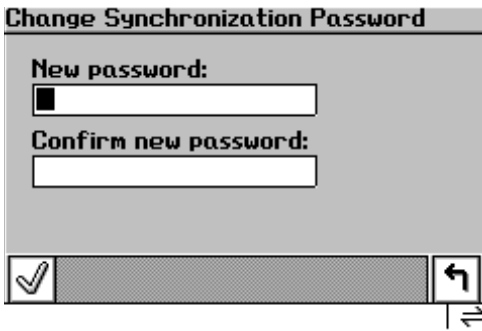

5. In the New password field, type a password.
6. In the Confirm new password field, retype the password.
7. Select the Save settings button on the toolbar to save your changes and return to the Control Panel. You will be prompted for your password when the PC desktop application attempts to synchronize with your Timeport device.



Setting Up Internet Fax Service

Before you can send fax messages, you must first identify the e-mail address of the Internet fax service you intend to use.

Note *The Internet Fax Service is a network and subscription dependent feature and may not be available in all areas.*

Control Panel enables you to record this information. If you make a change, your messaging device restarts so the change takes effect. When you are ready to send a fax, simply select, in Contacts, the fax address for the person you want to contact.

To set up an Internet fax service:

1. Select the Control Panel application from the Home screen.
2. Select the Fax Gateway icon from Control Panel.

Fax Gateway

Enter the email address for your fax gateway service. Do not enter the fax number or @ sign.

Example: faxaway.com

Enter fax gateway address:

faxaway.com

3. Type the email address for the fax service.

TIP *Do not enter the fax number or "@" sign.*

4. Select the Save settings button from the toolbar to save the information and return to the Control Panel.



Specifying a Printer

You can print messages, memos, tasks, contact information, and other information to compatible printers that support infrared (IR) beaming.

Use the Printer Selection feature to specify a default IR-enabled printer.

To specify printer settings:

1. Select the Control Panel application from the Home screen.
2. Select the Printer Selection icon from the Control Panel.

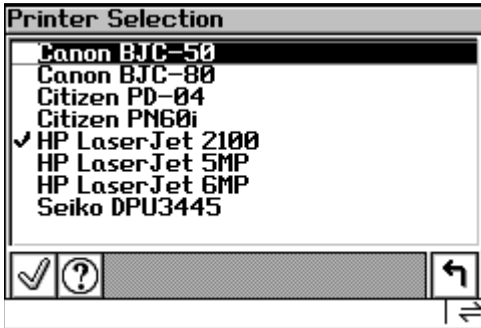

3. Select a default printer.
4. Select the Save settings button on the toolbar.



Specifying Beaming Settings

Use the Beaming Settings feature to specify how many times you want your device to attempt to beam information to another compatible device.

To specify beaming settings:

1. Select the Control Panel application from the Home screen.
2. Select the Beaming Settings icon from the Control Panel.

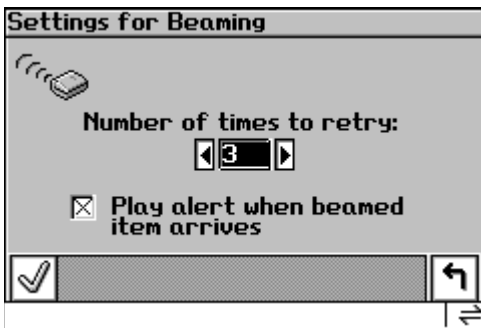

3. In the Number of times to retry field, press the NAVDISC left or right to increment or decrement the number of attempts.

- If you want a message pop-up to appear whenever you receive a beamed item, choose the Play alert when beamed item arrives option.
- Select the Save settings button from the toolbar.

Customizing the User Interface

The Control Panel provides you with the following features that enable you to adjust your Timeport P935 device to reflect your preferences:

- Contrast
- Key Clicks
- Date and Time
- Font sizes
- Home Screen Manager
- Transmit Status

Setting the Contrast Level

Using Contrast, you can adjust the display screen contrast level.

To use the contrast calibration guide:

- Select the Control Panel application from the Home screen.
- Select the Contrast icon from the Control Panel.

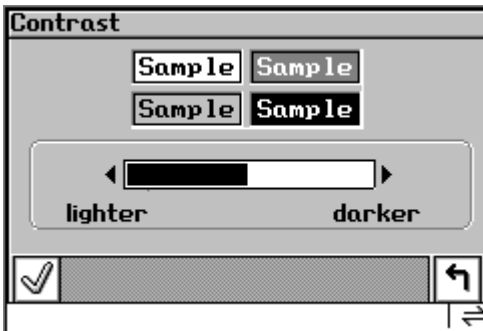

- Press the NAVDISC left or right to change the contrast.

TIP Watch the sample boxes to see how the shades of black, dark gray, light gray, and white are affected by your contrast selection.

4. Select the OK button from the toolbar when the desired contrast level is reached.

Note *You can also set the contrast by holding down the ALT key and then pressing the BACKLIGHT key until the desired contrast is reached.*



Using Key Clicks

Key Clicks enables you to turn on or off the audible keyboard clicks.

To set key clicks:

1. Select the Control Panel application from the Home screen.
2. Select the Key Clicks icon from the Control Panel.

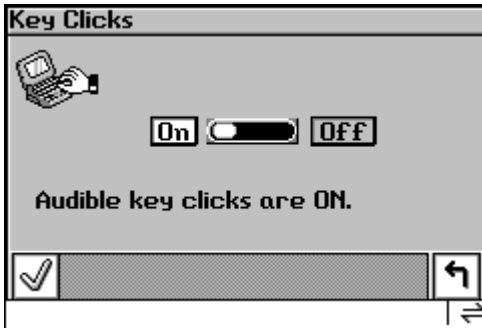

3. Press the NAVDISC left or right to toggle key clicks on and off.
4. Select the Save settings button from the toolbar to save the settings and return to Control Panel.

AA Setting Font Sizes

You can choose to display all messages, memos, and tasks in one of three font sizes.

To select message font size:

1. Select the Control Panel application from the Home screen.
2. Select the Font sizes icon from Control Panel.

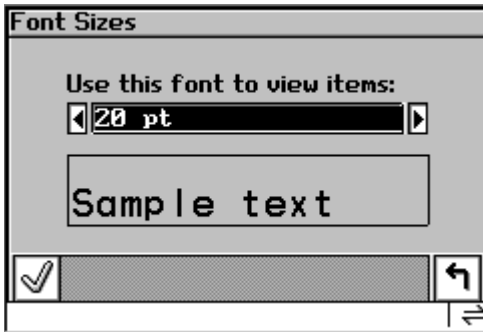

3. In the Use this font to view items field, choose one of the following font sizes:

12 pt Sample Text

20 pt Sample Text

25 pt Sample Text

4. Select the Save settings button from the toolbar to return to the Control Panel.



Using the Home Screen Manager

The Home Screen Manager enables you to specify the order in which you want applications to appear on the Home screen. You can also assign hot keys to applications. Hot keys enable you to launch an application from the Home screen by simply pressing a number.

In addition, you can specify whether to use the Menu Wheel or Desktop format as your default Home screen.

To arrange applications on the menu wheel:

1. Select the Control Panel application from the Home screen.
2. Select the Home Screen Manager icon from the Control Panel. The applications appear grouped in the order in which they appear on the Home screen.

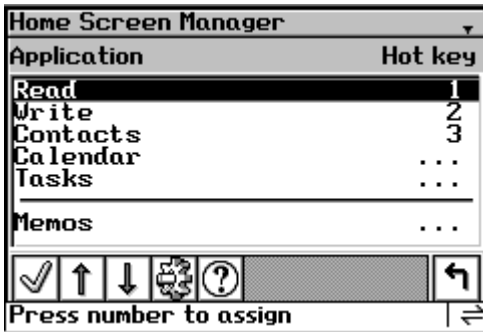

3. Highlight the application you want to move and select the Move app up or Move app down button from the toolbar, as applicable.
4. To change the application's hot key assignment, make certain the application is highlighted, then press the number key you want to assign.
5. Repeat Steps 3 and 4 for any other applications that you want to move on the Home screen or assign hot keys.

TIP You can assign up to nine hot keys.

6. Select the Settings for Home Screen button from the toolbar.

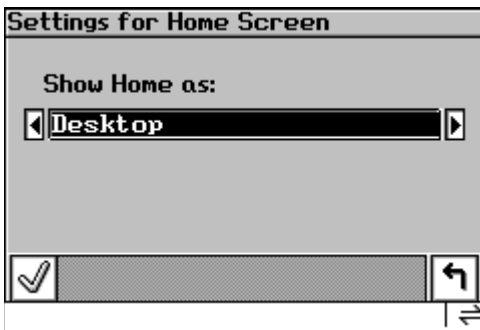

7. Press the NAVDISC left or right to choose Menu Wheel or Desktop as your Home screen preference.
8. Select the Save settings button from the toolbar to return to the Home Screen Manager main screen.
9. Select Save Settings to accept your changes and return to the Control Panel screen.



Setting the Date and Time

The Date and Time feature enables you to set the current time and date on your messaging device, specify options for moving between time zones, and choose a format for displaying times and dates on your device.

To set the date and time:

1. Select the Control Panel application from the Home screen.
2. Select the Date and Time icon from Control Panel.

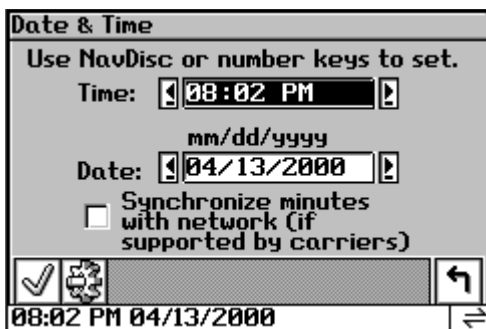

3. In the Time field, type the current time or press the NAV-DISC left or right to select the appropriate value.
4. In the Date field, type the current date or press the NAVDISC left or right to select the appropriate value.
5. To synchronize the minutes on your device with the carrier network, select the Synchronize minutes with network option. The carrier network will periodically update the minutes on your messaging device with the minutes on the carrier's network.

Note *This is a network dependent feature and may not be available in all areas.*

6. Select the Settings for Date & Time button from the toolbar.

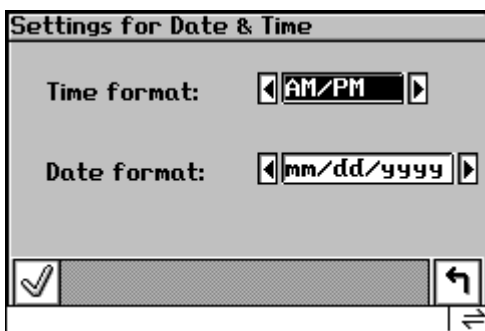

7. In the Time format field, press NAVDISC left or right to toggle between AM/PM or 24 hour.
8. In the Date format field, press NAVDISC left or right to cycle between one of the following date formats:
 - Day/Month/Year (dd/mm/yyyy)
 - Year/Month/day (yyyy/mm/dd)
 - Month/Day/Year (mm/dd/yyyy)
9. Select the Save settings button from the toolbar to return to the Date and Time main screen.
10. Select the Save settings button to return to the Control Panel.



Setting the Transmission Mode

The Transmit Status feature enables you set your device to the proper transmission mode before attempting to send or receive messages.

To set the transmission mode:

1. Select the Control Panel application from the Home screen.
2. Select the Transmit Status icon from Control Panel.



3. Select one of the following signal modes for message transmission:

- | | |
|-------|---|
| 2-way | Transmitter is ON. Messages can be sent and received. |
| 1-way | Transmitter is OFF. Messages can be received, but not sent. |
| Off | Transmitter is OFF. Messages cannot be sent or received. (Message are retained by the paging service until you change modes.)
This does not turn off your device, just radio frequency transmission. You can still use your Timeport P935 applications for non-messaging activities. |

Note Use this setting while on airplanes, in accordance with FAA regulation.

Note *Actual transmission status may vary depending on your paging service provider. Contact your provider if you need additional information about the transmission status for your coverage plan.*

4. Select the Save settings button from the toolbar to save your settings and return to the Control Panel.

TIP When moving to another zone, set your device to 2-way mode until you receive your first message. This enables the service provider to find your device. Zones are defined by the paging service provider, but in general, a major metropolitan area counts as a zone (e.g., greater Chicago area).

Creating Text Entry Shortcuts

The Timeport P935 device provides the following features that you can use as shortcuts when inserting frequently used text, words, or phrases into messages, message replies, or other application entries.

- Quick Text
- AutoType
- Signature



Using Quick Text

Quick Text enables you to create and store frequently used text. You can then insert that text when you are creating a message, replying to a message, or typing notes.

Quick Text entries are available whenever you compose a message or select the Insert text toolbar button.

To create a new Quick Text entry:

1. Select the Control Panel application from the Home screen.
2. Select the Quick Text icon from the Control Panel.



3. Select New Quick Text.

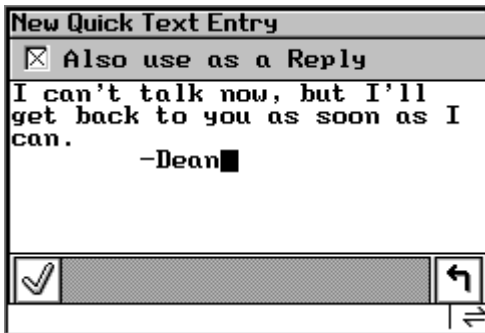

4. Type your new Quick Text entry.
5. If you want to make the Quick Text entry available for use when replying to messages, select the Also use as a reply option.
6. Select the Save entry button from the toolbar to save your Quick Text entry and return to the Control Panel.

To edit a Quick Text entry:

1. Select the Control Panel application from the Home screen.
2. Select the Quick Text icon from the Control Panel.
3. Highlight the Quick Text entry you want to modify and select the Edit entry button from the toolbar.
4. Change the text and the reply option as desired.
5. Select the Save entry button from the toolbar to save your changes and return to the Control Panel.

abc Using AutoType

AutoType saves you keystrokes when typing message text or other information by allowing you to type characters or abbreviations that are automatically replaced with other text as you type. You choose when AutoType entries are available based on settings you select.

To create an AutoType entry:

1. Select the Control Panel application from the Home screen.
2. Select the AutoType icon from the Control Panel.



3. Select New AutoType Entry.

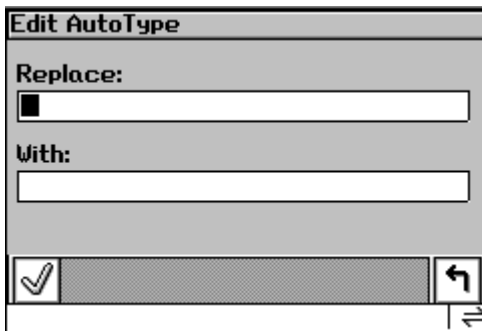

4. In the Replace field, type the characters that you want to type to initiate the AutoType correction.
5. In the With field, type the characters that you want to appear in place of the shortcut characters.
6. Select the Save settings button from the toolbar to save your AutoType entry and return to the Control Panel.

To specify which applications use AutoType entries:

1. On the main AutoType entry list, select the Settings for AutoType button from the toolbar.

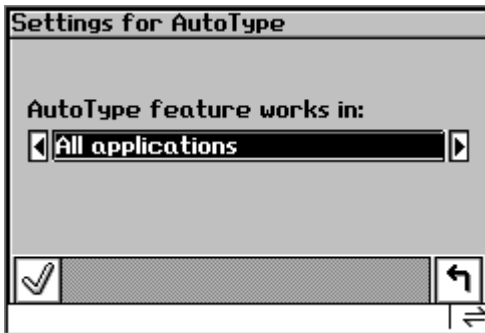

2. Select one of the following options
 - Enable AutoType entries in all applications.
 - Enable AutoType entries in all applications *except* Write.
 - Do not enable AutoType entries in any application.
3. Select the Save settings button from the toolbar to save your AutoType settings and return to the Control Panel.

Using Signature

Signature enables you to create a signature that is automatically appended to each message you send.

To create a signature:

1. Select the Control Panel application from the Home screen.
2. Select the Signature icon from the Control Panel.

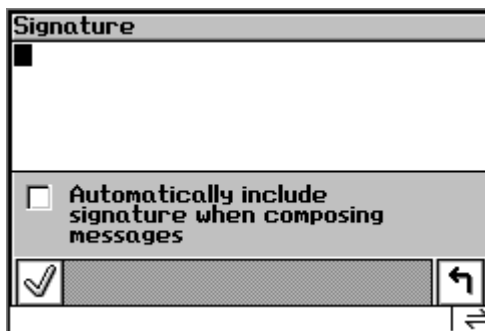

3. Type your message signature in the Signature text field.
4. To automatically append your signature to each message you send, select the Automatically include signature when composing messages option.

5. Select the Save settings button on the toolbar to save your changes and return to the Control Panel.



Entering Owner Information

The Owner Information feature lets you to enter your personal contact information into your messaging device.

Think of your owner information as an electronic business card, or vCard, that automates the exchange of personal information typically found on a traditional business card.

You can beam your owner information to other Timeport P935 devices, compatible hand-held organizers, PDAs (Personal Digital Assistants), and notebook PCs that support infrared communication.

Note *You cannot synchronize your owner information with your other contacts when using the Desktop synchronization software.*

To enter owner information:

1. Select the Control Panel application from the Home screen.
2. Select the Owner Information icon from Control Panel.

3. Type your first name, last name, company name, and title in the appropriate fields.
4. To make your contact information private, select the Private check box.

5. (Optional) Enter the following personal information:
 - Device type and wireless address
 - Main, work, home, mobile, and alternate phone numbers
 - Main, work, home, alternate, and web email addresses
 - Home and work fax number
 - Work address
 - Home address
 - Up to four additional pieces of information
6. To record notes, select the Notes button from the toolbar.
7. When you are finished entering your owner information, select the Save contact button from the toolbar.

Protecting Your Information



In many of the Timeport P935 applications, you can mark individual entries as private. You can then control whether the private entries are visible or hidden using Privacy Options.

To set privacy options:

1. Select the Control Panel application from the Home screen.
2. Select the Privacy Options icon from the Control Panel.

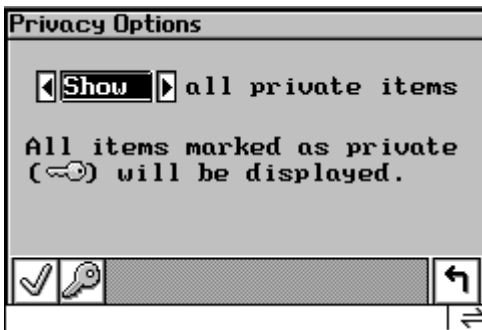

3. Do one of the following:
 - To make all entries that are marked private visible and accessible, choose Show.
 - To hide all items marked private, choose Hide.
4. Select the OK button from the toolbar.

To set privacy options:

1. Select the Control Panel application from the Home screen.

2. Select the Privacy Options icon from the Control Panel.
3. Select the Change password button from the toolbar.



4. In the Old password field, type your previous password, if applicable.
5. In the New password field, type a new password.
6. In the Confirm new password field, retype the new password.
7. Select the Save changes button from the toolbar to return to the Privacy screen.
8. Select the Save settings button from the toolbar to save your settings and return to the Control Panel.

Motorola Limited Warranty For Pagers

I. What this Warranty Covers and for How Long

The Motorola company listed below (Motorola) warrants this Pager and related accessories, including nickel cadmium batteries, battery charger and holsters manufactured and/or sold by Motorola (Products) against defects in materials and workmanship under normal use for a period of one year from the date the Products are purchased by the first end-user purchaser.

Motorola, at its option, will at no charge either repair, replace or refund the purchase price of any Products that do not conform with this warranty. Repair may include the replacement of parts with functionally equivalent reconditioned or new parts. Replacement may include providing a functionally equivalent "Motorola Certified Reconditioned/Refurbished/Pre-Owned" or a new Product. Products that have been repaired or replaced are warranted for the balance of the original warranty period or for 90 days from the date that you received the repaired or replaced Product, whichever is longer. All Products and/or parts for which replacements have been provided become Motorola's property.

Motorola warrants that each copy of any software supplied with the Products will be free from physical defects in the media that tangibly embodies the copy for a period of 90 days from the date the Products are purchased by the first end-user purchaser. Motorola, at its option, will at no charge repair or replace the media of any such software that contains defects in materials or workmanship in the media. No updates are provided. Motorola makes no warranty or representation that such software will meet your requirements or will work in combination with any hardware or applications software products provided by third parties, that the operation of the software products will be uninterrupted or error free, or that all defects in software products will be corrected.

This warranty extends to the first end-user purchaser only, and is not transferable.

II. Warranty Conditions

This warranty is valid only in the United States and Canada, and is Motorola's complete warranty for the Products. Motorola assumes no obligation or liability for changes to this warranty unless made in writing and signed by an officer of Motorola.

Motorola is not responsible in any way for any ancillary equipment not furnished by Motorola which is attached to or used in connection with the Products, or for operation of Products with any ancillary equipment, and all such equipment is expressly excluded from this warranty. Furthermore, Motorola is not responsible for any damage to Products resulting from the use of ancillary equipment not furnished by Motorola for use with the Products.

When Products are used in combination with ancillary or peripheral equipment not manufactured or supplied by Motorola, Motorola does not warrant the operation of the combination, and Motorola will not honor a warranty claim in which the Product is used in such a combination and it is determined by Motorola there is no fault with the Product. Motorola specifically disclaims any responsibility for any damage caused in any way by the use of accessories and peripherals not manufactured or supplied by Motorola, including but not limited to batteries, chargers, adaptors, and power supplies.

Motorola does not warrant any installation, maintenance, or service that it did not perform. SERVICE WORK PERFORMED BY SERVICE CENTERS OR OTHERS NOT AUTHORIZED BY MOTOROLA TO PERFORM SUCH WORK WILL VOID THIS WARRANTY.

III. What This Warranty Does Not Cover

1. Defects or damage resulting from: use of the Products in any manner not normal or customary; misuse, accident or neglect such as dropping the Products onto hard surfaces, contact with water, rain or extreme humidity, contact with sand, dirt or the like, contact with extreme heat, spills of food or liquid; improper testing, operation, maintenance, installation, adjustment; or any alteration or modification of any kind.
2. Physical damage to the surface of the Products, including scratches or other damage to displays, or other externally exposed parts.
3. Products disassembled or repaired in such a manner as to adversely affect performance or prevent adequate inspection and testing to verify any warranty claim.
4. Products on which serial numbers or date tags have been removed, altered or obliterated.
5. Products on which the board serial numbers do not match each other, or on which the board serial numbers do not match the housing.

6. Products with non-conforming or non-Motorola housings or parts.
7. Failure of Products due primarily to any communication service or signal you may subscribe to or use with the Products.

Flat rate repair rates apply to Products not covered by this warranty. TO OBTAIN INFORMATION ON PRODUCTS NEEDING REPAIRS NOT COVERED BY THIS WARRANTY, CALL THE NUMBER LISTED BELOW. INFORMATION WILL BE PROVIDED REGARDING REPAIR RATES, METHOD OF PAYMENT AND WHERE TO SEND THE PRODUCT.

IV. How to Get Warranty Service

To get warranty service, please call:

1-800-548-9954 USA

1-800-461-4575 Canada

1-800-793-7834 TTY

You will receive directions on how to mail the Products to Motorola.

All Products shipped to Motorola Service Centers must be shipped with freight and insurance prepaid. Along with the Products you must include a copy of your receipt, bill of sale, or some other comparable proof of purchase, a written description of the problem and, most importantly, your address, and telephone number. RETAIN THE ORIGINAL OF YOUR PROOF OF PURCHASE. Products that are repaired or replaced under this warranty will be shipped to you at Motorola's expense for the freight and insurance. If additional information is needed, please contact Motorola at the number at the bottom of this document.

V. General Provisions

THIS IS THE COMPLETE WARRANTY FOR THIS PRODUCT BY MOTOROLA AND SETS FORTH YOUR EXCLUSIVE REMEDIES. THIS WARRANTY IS GIVEN IN LIEU OF ALL OTHER EXPRESS WARRANTIES. IMPLIED WARRANTIES, INCLUDING WITHOUT LIMITATION THE IMPLIED WARRANTIES OF MERCHANTABILITY AND FITNESS FOR A PARTICULAR PURPOSE, ARE GIVEN ONLY IF SPECIFICALLY REQUIRED BY APPLICABLE LAW. OTHERWISE, THEY ARE SPECIFICALLY EXCLUDED. IN NO EVENT SHALL MOTOROLA BE LIABLE, WHETHER IN CONTRACT OR TORT (INCLUDING NEGLIGENCE) FOR DAMAGES IN EXCESS OF THE PURCHASE PRICE OF THE PRODUCT, OR FOR ANY INDIRECT, INCIDENTAL, SPECIAL OR CONSEQUENTIAL DAMAGES OF ANY

KIND, OR LOSS OF REVENUE OR PROFITS, LOSS OF BUSINESS, LOSS OF INFORMATION OR DATA, OR OTHER FINANCIAL LOSS ARISING OUT OF OR IN CONNECTION WITH THE USE OR INABILITY TO USE THE PRODUCT, TO THE FULL EXTENT THESE DAMAGES MAY BE DISCLAIMED BY LAW.

VI. Patent and Software Provisions

Motorola will defend at its own expense, any suit brought against you to the extent that it is based on a claim that the Products infringe a United States patent. Motorola will pay those costs and damages finally awarded against you in any such suit which is attributable to any such claim. The defense and payments by Motorola are conditioned on the following: (a) that you will notify Motorola promptly in writing any notice of the claim; and (b) that Motorola will have sole control of the defense of the suit and all negotiations for its settlement or compromise; and (c) should the Products become, or in Motorola's opinion be likely to become, the subject of a claim of infringement of a United States patent, that you will permit Motorola, at its option and expense, either: to procure for you the right to continue using the Products or parts; to replace or modify them so that they become non-infringing; or to grant you a credit for such Products or parts as depreciated and accept their return. The depreciation will be an equal amount per year over the lifetime of the Products, accessories, battery or parts as established by Motorola.

Motorola will have no liability to you with respect to any claim of patent infringement which is based upon the combination of the Products or parts furnished under this limited warranty with software, apparatus or devices not furnished by Motorola. Motorola will have no liability for the use of ancillary or peripheral equipment or software not furnished by Motorola which is attached to or used in connection with the Products. The foregoing states the entire liability of Motorola with respect to infringement of patents by the Products, accessories, batteries or any parts of them.

Laws in the United States and other countries preserve for Motorola certain exclusive rights for copyrighted Motorola software such as the exclusive rights to reproduce in copies and distribute copies of the Motorola software. Motorola software may be copied into, used in and redistributed with only the Products associated with such Motorola software. No other use, including without limitation disassembly or reverse engineering, of such Motorola software or exercise of exclusive rights in such Motorola software is permitted.

VII. State Law and Other Jurisdiction Rights

SOME STATES AND OTHER JURISDICTIONS DO NOT ALLOW THE EXCLUSION OR LIMITATION OF INCIDENTAL OR CONSEQUENTIAL DAMAGES, OR LIMITATION ON HOW LONG AN IMPLIED WARRANTY LASTS, SO THE ABOVE LIMITATIONS OR EXCLUSIONS MAY NOT APPLY TO YOU.

This warranty gives you specific legal rights, and you may also have other rights which vary from jurisdiction to jurisdiction.

Call first for information on obtaining warranty service. If you otherwise need to correspond with Motorola about this Product, write to:

Motorola:

In the USA:
Motorola, Inc.
1500 Gateway Blvd.
Boynton Beach, Florida
USA 33426-8292

In Canada:
Motorola Canada Limited
5875 Whittle Road
Mississauga, Ontario L4Z 2H4

1-800-548-9954 USA
1-800-793-7834 TTY

1-800-461-4575 Canada

INFORMATION ON MOTOROLA OPTIONAL EXTENDED LIMITED WARRANTIES FOR PAGERS

An optional extended limited warranty is available to first end-user purchasers. The optional extended limited warranty is in place of the standard limited warranty, above, and includes some additional services for an additional fee. If you wish to inquire about these services, please call Motorola at the number below. If you have purchased the optional extended limited warranty with your Product, your carrier should have provided you with a copy of those terms and conditions. If you wish to verify whether or not you have this optional extended coverage, receive another copy of the optional extended limited warranty, obtain additional information or purchase an optional extended limited warranty, please call Motorola at:

1-800-548-9954 USA

1-800-461-4575 Canada

1-800-793-7834 TTY

Copyright 2000 Motorola. All rights reserved.

Index

A

about

- Alarm Clock, 103
- Alert Jukebox, 113
- Calculator, 107
- Calendar, 79
- categories, 33
- Contacts, 69
- copy, 35
- cut, 35
- Draft folder, 61
- Express, 45
- Find, 43
- folders, 59
- Help, 47
- Inbox, 60
- inserting text, 36
- Memos, 97
- message rules, 65
- messages, 49
- Outbox, 61
- paste, 35
- private entries, 39
- Read, 56
- send, 38
- Sent Messages folder, 62
- Tasks, 89
- Trashcan, 40
- Write, 50

accessories, 28

activation, 10

add

- alarms, 104
- calendar event, 81
- category, 34
- contact, 69
- folders, 63
- jukebox alerts, 114

- memo, 98

- message rules, 65
- one-time recipient, 52
- private entries, 40
- tasks, 90

Address Book, See Contacts, 69

Addresses, See Contacts, 69

airline travel, 30

Alarm Clock

- about, 103
- features, 103
- settings, 105
- sounding mode, 106

alarms

- adding, 104
- editing, 104
- off, 105
- on, 105
- setting, 104
- viewing alarms, 103

alert

- volume level, 29, 30

Alert 2000, See Alert Jukebox, 113

Alert Jukebox

- about, 113
- features, 113

AlertScript

- about, 117
- quick reference, 129
- sample tunes, 126

Alt mode, 20

applications

- basic concepts, 33
- common features, 33
- screens, 23
- starting, 22

attached message replies, 55

B

- Back key, 20
- Backlight key, 20
- basic concepts, 33
- battery, 24
 - inserting, 26
 - recharge in pager, 25
 - recharging, 25
 - replacing, 26
 - status indicator, 25
- beam
 - using Send, 38
- book conventions, 10

C

- Calculator
 - about, 107
 - buttons, 107
 - features, 107
 - formulas, 109
 - keyboard shortcuts, 108
 - settings, 111
 - using, 109
- Calendar
 - about, 79
 - adding event, 81
 - delete event, 85
 - edit event, 85
 - features, 79
 - other functions, 88
 - settings, 87
 - viewing, 79
- calendar event
 - beaming, 38
 - printing, 38
 - sending, 38
- Calendar views
 - Day, 80
 - Month, 81
 - Week, 80

- Caps Lock, 20
- category
 - about, 33
 - adding, 34
 - deleting, 35
 - renaming, 34
- charger
 - docking station, 27
- charger base, 24
- completed tasks, 92
- connect pager to PC, 27
- contact
 - add to mailing list, 75
 - adding, 69
 - beaming, 38
 - deleting, 72
 - editing, 71
 - printing, 38
 - sending, 38
 - viewing, 73
- Contacts
 - about, 69
 - custom fields, 74
 - features, 69
 - mailing lists, 75
 - other functions, 77
 - settings, 74
 - sorting entries, 74
- conventions, 10
- copy
 - about, 35
 - text in edit fields, 36
 - text in non-edit fields, 36
- create
 - folder, 63
 - jukebox alerts, 115
 - message rules, 65
- custom
 - contact information, 74
- custom reply, 57
- cut
 - about, 35

text, 35

D

date

set, 29

date and time

inserting, 37

Day view, 80

delete

calendar event, 85

category, 35

category (Memos), 100

category (Tasks), 94

contact, 72

folders, 64

items in Trashcan, 42

jukebox alerts, 116

memo, 99

message, 59

message rules, 67

tasks, 93

Desktop, 21

device

off, 28

on, 28

docking station

about, 27

connecting, 27

Draft folder

about, 61

draft messages, 61

E

edit

alarms, 104

calendar event, 85

contact, 71

folders, 63

memo, 98

message rules, 66

tasks, 91

Enter key, 20

Express

about, 45

F

FAA regulations, 30

features, 9

Find

about, 43

find

text, 43

words and phrases, 43

flip, 19

folder

Draft, 61

moving message, 58

Sent Messages, 62

folders

about, 59

creating, 63

deleting, 64

icons, 59

formulas, 109

forward message, 58

G

group, See mailing list, 75

H

Help

about, 47

hide

private entries, 40

holster, 28

Home key, 20

Home screen

Desktop, 21

Menu Wheel, 21

I

icons

- Alert Jukebox, 113
- battery gauge, 25
- Calculator buttons, 107
- calendar views, 79
- folders, 59
- Inbox, 60
- Outbox, 61
- task priorities, 89
- volume level, 29, 30

Inbox

- about, 60
- icons, 60

infrared port, 27

insert

- current date/time, 37
- Quick Text, 37
- signature, 37
- text, 37

insert battery, 26

insert text

- about, 36

IR port, 27

J

jukebox alerts

- composing, 115
- deleting, 116
- downloading from web, 114
- off, 115
- on, 115
- quick reference, 129
- sample tunes, 126

K

keyboard

- navigation, 20
- shortcuts (Calculator), 108

keys

- Alt, 20
- Back, 20
- Backlight, 20
- Enter, 20
- Home, 20
- NavDisc, 20
- Select, 20
- Shift, 20
- TAB, 20

L

LCD screen, 19

loud, 29, 30

M

mailing lists

- contacts, 75

marking

- private entries, 40

memo

- add, 98
- beaming, 38
- deleting, 99
- edit, 98
- printing, 38
- sending, 38
- viewing, 97

Memos

- about, 97
- features, 97
- other functions, 101

Menu Wheel, 21

message rules

- about, 65

messages

- about, 49
- attaching replies, 55
- creating rules, 65
- deleting, 59

- deleting rules, 67
- edit rules, 66
- forwarding, 58
- moving, 58
- reading, 56
- receiving new, 49
- replying, 57
- rules, 65
- sending, 51
- settings, 67

Month view, 81

move message, 58

N

NavDisc, 20

Navigation, 20

navigation

- keyboard, 20

new message, 49

Notepad, See Memos, 97

O

Outbox

- about, 61
- icons, 61

overview, 9

Timeport P935, 19

owner information, 29

P

pager

- off, 28
- on, 28

paging service

- activate, 10

paste

- about, 35
- text, 36

PIM applications, 33

PIM information

- sending, 38

PIN from paging service, 10

playing alerts, 114

power

- off, 28
- on, 28

print

- using Send, 38

private entries

- about, 39
- hiding, 40
- marking, 40
- showing, 40

Q

Quick Text

- inserting, 37

Quick Text reply, 57

R

radio signal

- set mode, 30

Read

- about, 56
- features, 49
- settings, 67

read messages, 56

receive

- new message, 49

recharge battery, 25

- in pager, 25

rename

- category, 34

reply

- attached, 55
- custom, 57
- Quick Text, 57

reply to message, 57

respond

- new message alert, 50
- restore items in Trashcan, 41
- restrictions
 - environmental, 30
- rules, 65
 - deleting, 67
 - editing, 66

S

- Scheduler 2000, See Calendar, 79
- search, 43
- searching, 43
- Select key, 20
- send
 - about, 38
 - formatted text, 38
 - PIM information, 38
- send message, 51
- service activation, 10
- set transmission mode, 30
- setting
 - alarms, 104
- settings
 - Alarm Clock, 105
 - Calculator, 111
 - Calendar, 87
 - Contacts, 74
 - Read, 67
 - Tasks, 94
 - Trashcan, 42
- Shift mode, 20
- shortcuts
 - starting applications, 22
- show
 - private entries, 40
- signature
 - inserting, 37
- silent, 29, 30
- sleep mode, 19
- soft, 29, 30

- sort
 - contacts, 74
 - tasks, 94
- symbols, 20

T

- TAB key, 20
- task
 - beaming, 38
 - printing, 38
 - sending, 38
- Tasks
 - about, 89
 - features, 89
 - other functions, 95
 - prioritizing, 89
 - settings, 94
- tasks
 - adding, 90
 - deleting, 93
 - editing, 91
 - mark complete, 92
 - sorting, 94
 - viewing, 92
- text
 - copying, 36
 - cutting, 35
 - finding, 43
 - inserting, 37
 - pasting, 36
- The, 19
- time
 - set, 29
- Timeport P935
 - common features, 33
 - features overview, 19
- To Do, See Tasks, 89
- transmission
 - set mode, 30
- transmission mode
 - aircraft, 30

Trashcan
 about, 40
 deleting items in, 42
 restoring items in, 41
 settings, 42
 viewing items in trash, 41

U

undelete, 41
using
 keyboard keys, 20
 special function keys, 20

V

vcard, 29
vibrate, 29, 30
view
 alarms, 103
 Calendar events, 79
 contact, 73
 memo, 97
 tasks, 92
 Trashcan items, 41
volume level
 setting, 29, 30

W

web
 jukebox alerts, 114
Week view, 80
Write
 about, 50
 features, 49

